



MICHELIN[®] ENERGY GUARD

INSTALLATION GUIDE AND OWNER'S MANUAL



business.michelinman.com

Copyright ©2022 Michelin North America, Inc. All rights reserved



The information contained in this manual is the sole property of Michelin North America, Inc. ("Michelin") and may not be used for any other purpose than as a reference for MICHELIN® Energy Guard Aerodynamic Solution ("Energy Guard") customers. It may not be reproduced or reprinted without the express written permission of Michelin. All copyrightable text and graphics, the selection, arrangement, and presentation of all materials (including information in the public domain), and the overall design of this manual are the property of Michelin. All rights are reserved. Permission is granted to download and print this manual only for Energy Guard customers and only for the purposes of viewing, reading, and retaining this manual for reference. Any other use, solicitation with, copying, distribution or modification of information or materials in this manual, whether in electronic or hard copy form, without the express prior written permission of Michelin is strictly prohibited.

Read this manual completely prior to installation. This is important for the safe and effective operation of the Energy Guard Solution.

The manual provides the Energy Guard customer with a complete user's guide to install the Energy Guard Solution.

TABLE OF CONTENTS

TABLE OF CONTENTS	3
Michelin Recommendations	4
Recommended Personal Protective Equipment	4
Installation Recommendations.....	4
Inspection and Maintenance Recommendations	5
Introduction	5
Trailer Skirt Installation	7
Recommended Tools	7
Parts List	8
Installing the Trailer Skirt	10
Complete the Post-Installation AND PERIODIC INSPECTION Checklist.....	20
Top End of Trailer Fairing Installation	21
Recommended Tools/Equipment	22
Parts List	23
Installing the Top End of Trailer Fairing	23
Complete the Post-Installation Checklist	30
Side End of Trailer Fairings Installation	31
Recommended Tools/Equipment	31
Solid Rivet Option.....	32
Parts List	32
Installing the Side End of Trailer Fairing.....	34
Complete the Post-installation Checklist	41
Wake Reducer Installation	42
Recommended Tools	42
Parts List	43
Installing the Wake Reducer	45
Installation of the wake reducer is now complete. Use the post installation checklist to verify the procedures were followed correctly.....	51
Complete the Post-installation Checklist	52
Mud Flap Installation	53
Recommended Tools	53
Parts List	54
Installing the Mud Flaps	54
Installation of the mud flap is now complete. Use the post installation checklist to verify the procedures were followed correctly.	58
Complete the Post-Installation Checklist	58
Supplemental Instructions	60

MICHELIN RECOMMENDATIONS

 WARNING	Failure to follow all installation instructions can lead to component separation from the vehicle in service, which can lead to accidents, injury, and death.
--	---

 NOTICE	Installation of the Energy Guard top end of trailer fairing can add 1.75 inches of height at the rear of the trailer. It is the end user's responsibility to ensure installation of these components does not impact legal height requirements and to plan routes accordingly.
---	--

RECOMMENDED PERSONAL PROTECTIVE EQUIPMENT

Michelin recommends the following personal protective equipment (PPE) during installation:

- Safety glasses
- Gloves
- Bump cap/hard hat
- Hearing protection
- Working at heights safety restraints
- Steel-toed shoes

 NOTICE	Use proper lifting techniques as some components and packaging can weigh up to 70 pounds.
---	---

INSTALLATION RECOMMENDATIONS

Effective function of the Energy Guard Solution relies on correct installation. Michelin recommends the following to ensure proper installation:

- Prior to installation, review this manual carefully.
- Follow the inspection procedure for each component.
- Use a calibrated torque wrench during installation and follow instructions for each bolt torque value.
- Do not modify any components prior to reviewing this installation manual or contacting the manufacturer. Consult the manufacturer if desired modifications do not conform with the component installation sections.
- Use Michelin-supplied mounting hardware and fasteners. Use of non-Michelin-supplied fasteners could result in a voided warranty.

INSPECTION AND MAINTENANCE RECOMMENDATIONS

Michelin recommends the following inspection and maintenance guidelines:

- Inspect the Energy Guard Solution components prior to each trip and as part of regular periodic maintenance practices.
- Trailer skirt panels, end of trailer fairings, and wake reducers generally may be repaired in accordance with the owner's maintenance and repair policies, as long as damages incurred are not structural in nature and do not diminish the integrity of the components. Contact your Michelin representative for guidance on repair options.

INTRODUCTION

The MICHELIN® Energy Guard Solution controls the vehicle's airflow and delivers significant fuel savings without raising maintenance costs. The following figure shows the MICHELIN® Energy Guard Aerodynamic Solution components.

Figure 1: MICHELIN® Energy Guard Solution Components

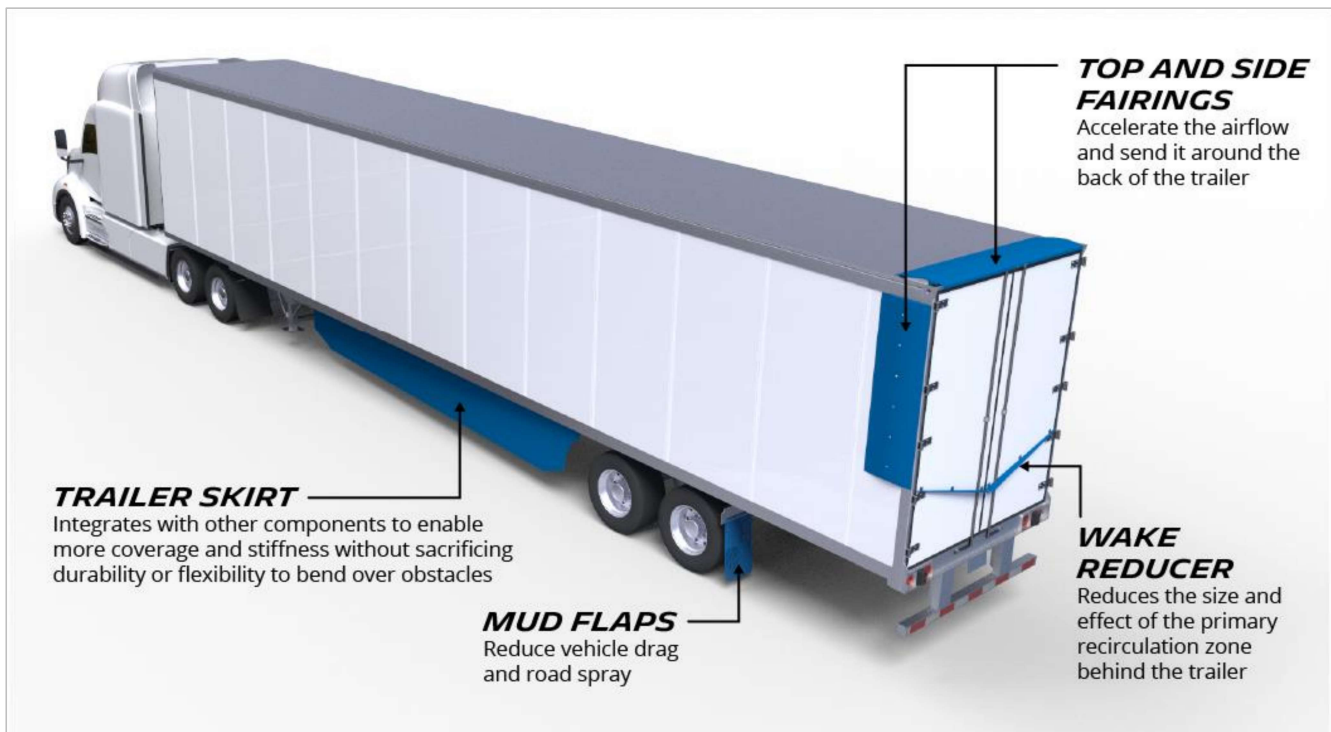

This manual provides instructions to install the Trailer Skirt, Top End of Trailer Fairing (top fairing), Side End of Trailer Fairings (side fairings), Wake Reducer, and Mud Flaps.

To learn more about MICHELIN® Aerodynamic Solutions, including the Energy Guard Solution, visit <https://www.michelintruck.com/services-and-programs/aerodynamic-solutions/>. For more information or technical questions, please contact your Michelin Service Sales Representative directly or Michelin Consumer Care at 1-888-622-2306.

The following table provides specifications for MICHELIN® Energy Guard Solution components.

Table 1: MICHELIN® Energy Guard Solution Specifications

MICHELIN® ENERGY GUARD SOLUTION (53' Trailer)		
	DRY VAN	REFRIGERATED
Overall Weight* (lb)	275	258
Full Installation Time**	2.5 hr	2.5 hr
MICHELIN® Aerodynamic Trailer Skirt		
Weight* (lb)	208	191
Left Skirt Dimension	264" x 33.25"	221" x 33.25"
Right Skirt Dimension	264" x 33.25"	264" x 33.25"
Skirt Material	Fiberglass reinforced composite	
Brackets	Aluminum head with stainless steel leaf spring	
Available Colors	Black or white	
Install Time (per set)**	35 min (two technicians)	
MICHELIN® Top End of Trailer Fairing		
Weight (lb)	29	
Flange Width	100" to 102.5"	
Material	Thermoplastic polyolefin (TPO)	
Available Colors	White	
Install Time**	20 min (one technician)	
MICHELIN® Side End of Trailer Fairings		
Weight* (lb/set)	27	
Side Wall Type	Smooth or corrugated	
Material	Thermoplastic polyolefin (TPO)	
Available Colors	White	
Install Time (per set)**	30 min (one technician)	
MICHELIN® Wake Reducer		
Weight* (lb/set)	2	
Material	Fiberglass reinforced composite	
Available Colors	White	
Install Time (per set)	15 min (one technician)	
MICHELIN® Aerodynamic Mud Flaps		
Sizes	18" W x 30" L	24" W x 30" L
Weight (lb/set)	7	9
Material	High-grade impact-resistant nylon	
Available Colors	Black	
Install Time (per set)**	5 min (one technician)	
*Includes brackets and hardware without spacers.		
**Time required for experienced installers; actual times vary.		

TRAILER SKIRT INSTALLATION

The following figure shows the MICHELIN® Energy Guard Solution Trailer Skirt.

Figure 2: MICHELIN® Energy Guard Solution Trailer Skirt



This section provides steps to install the trailer skirt on refrigerated and dry van trailers.

RECOMMENDED TOOLS

- 3/8" torque wrench capable of 10 to 20 ft-lb
- 3/16" hex drive socket (3/8" drive)
- 1/2" deep-well socket (3/8" drive)
- 1/2" combination wrench
- Power drill/driver
- 5/16" drill bit
- Chalk line reel
- 25' tape measure
- Dry/wet erase marker

PARTS LIST

The following table lists the trailer skirt variations.

Table 2: Trailer Skirt Parts

ITEM	PART NUMBER	DESCRIPTION	QUANTITY
A	SKT-LA-26433-01	22' roadside skirt (white)	One roadside and one curbside skirt are required per trailer
	SKT-LA-26433-02	22' roadside skirt (black)	
B	SKT-RA-26433-01	22' curbside skirt (white)	
	SKT-RA-26433-02	22' curbside skirt (black)	
C	SKT-LA-22133-01	18'5" roadside skirt (refrigerated only) (white)	
	SKT-LA-22133-02	18'5" roadside skirt (refrigerated only) (black)	

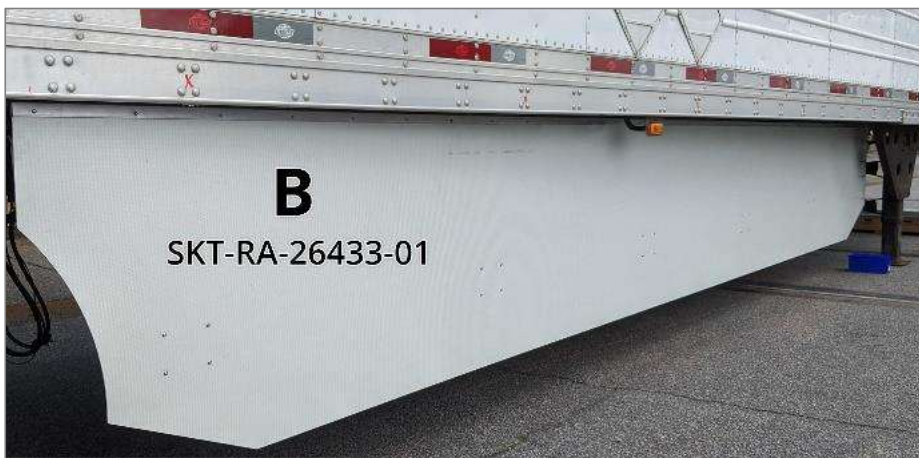

The following table lists the trailer skirt brackets.

Table 3: Trailer Skirt Brackets

ITEM	PART NUMBER	DESCRIPTION	QUANTITY
D	SKT-BA-0005-01	<ul style="list-style-type: none"> Skirt bracket assembly (most common) Compatible with 1.75" to 2.5" wide cross-members 	11-12
	SKT-BA-0006-01	<ul style="list-style-type: none"> Skirt bracket assembly (uncommon) Compatible with 1.5" to 1.625" wide cross-members 	11-12
E	SKT-BC-0001-01	<ul style="list-style-type: none"> Beam clamp Compatible with 1/8" to 5/16" thick cross-members 	2/bracket
F	SKT-SS-0004-02	<ul style="list-style-type: none"> Bracket slider Compatible with one-piece slider 	1/bracket
G	SKT-PS-0003-01	<ul style="list-style-type: none"> 1/2" spacer Optional, can be stacked 	As needed for variation in cross-member heights, up to 3/bracket

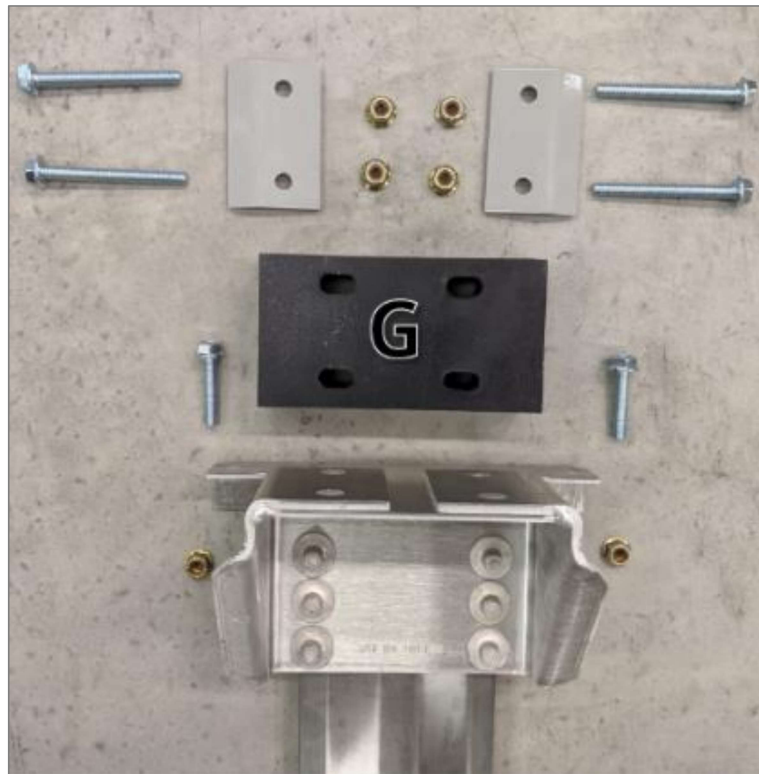
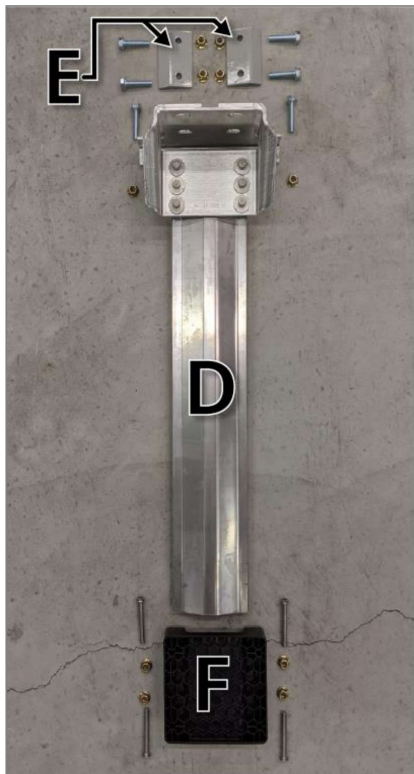

The following table lists the trailer skirt fasteners.

Table 4: Trailer Skirt Fasteners

ITEM	PART NUMBER	DESCRIPTION	QUANTITY
H	HFB85168112Z-FT	<ul style="list-style-type: none"> • 5/16"-18 x 1.5" bracket bolt • 1/2" hex head 	6/bracket
I	HNFE51618-G	<ul style="list-style-type: none"> • 5/16"-18 flanged nylock nut • 1/2" hex head 	10/bracket
J	FST-BT-0001-01	<ul style="list-style-type: none"> • 5/16"-18 x 2.25" stainless steel bolt • Button head, 3/16" allen drive 	4/bracket
K	HFB5516803Z-FT	<ul style="list-style-type: none"> • 5/16"-18 x 3" bracket bolt • Optional, used with spacers 	4/bracket (optional)

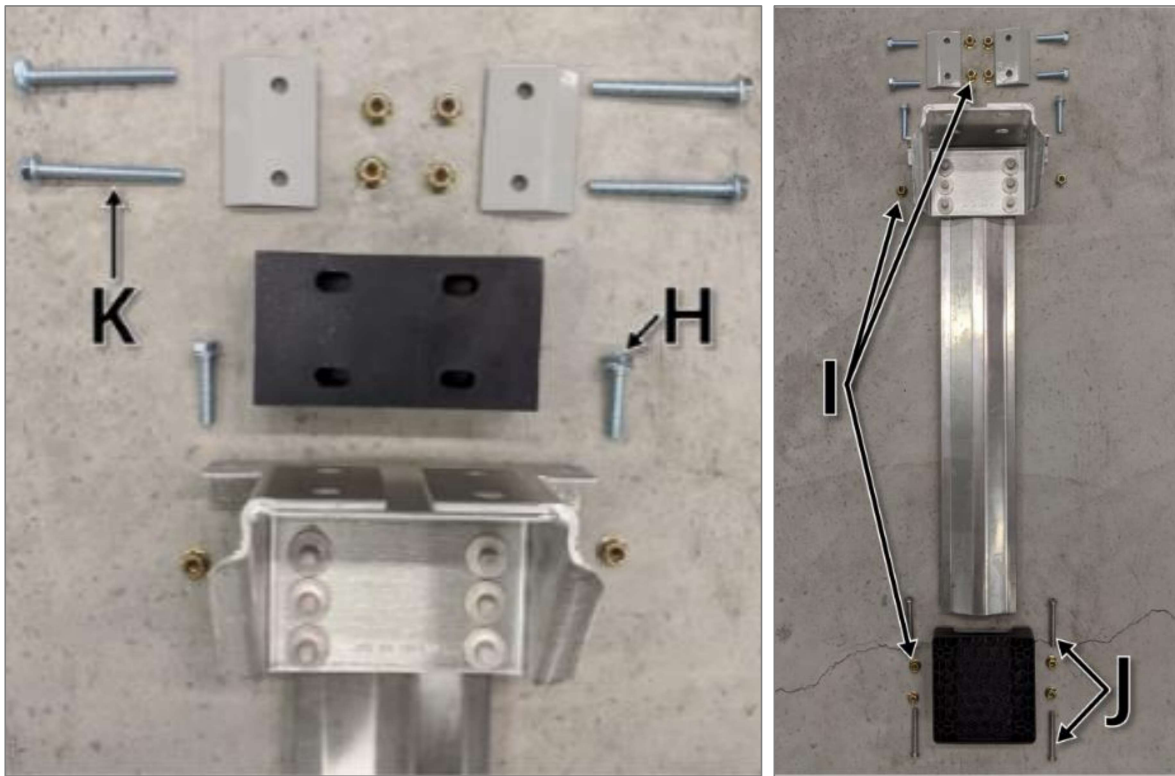

INSTALLING THE TRAILER SKIRT

Complete the following tasks in the following order to install the trailer skirt.

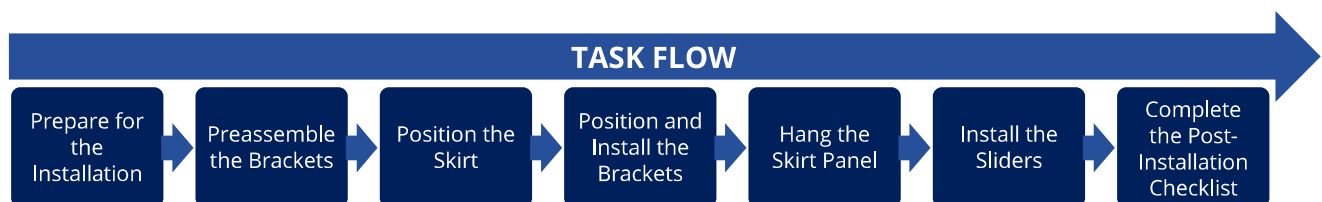

Prepare for the Installation

1. Verify all the required parts are present from the parts list and undamaged.
2. Inspect the trailer and components for damage that may prevent proper installation, operation, or component integrity. Check for interference with the spare tire or other equipment.

Preassemble the Brackets

1. Assemble the skirt bracket components and note that up to three 1/2-inch spacers (G) can be used if you have variation in cross-member heights. Use the longer bracket bolts (K) with the spacers.

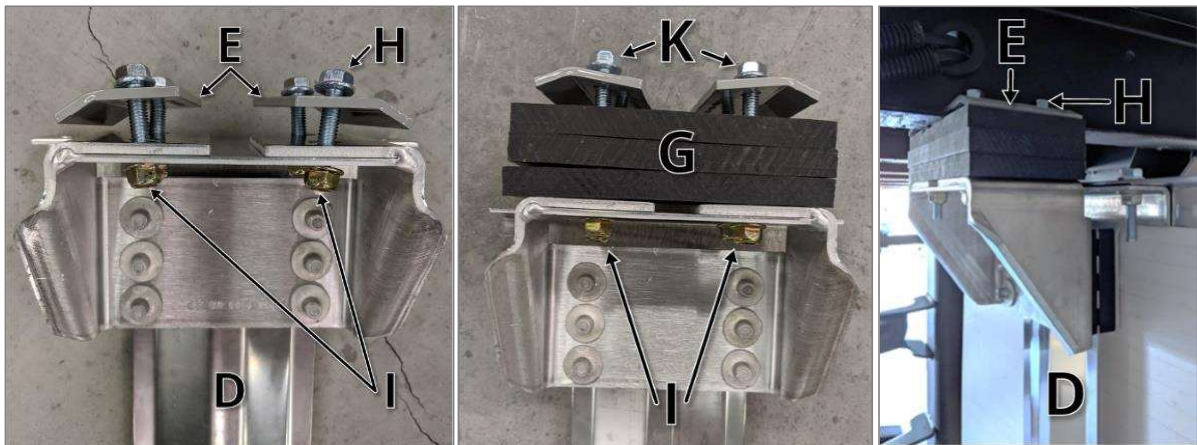

2. Slide the bracket slider (F) onto the bottom of the leaf spring in the orientation shown below.



Position the Skirt

Mark the location for the trailer skirt with a chalk line. For a refrigerated trailer, ensure the skirt does not go over the tank. See the following images for examples.

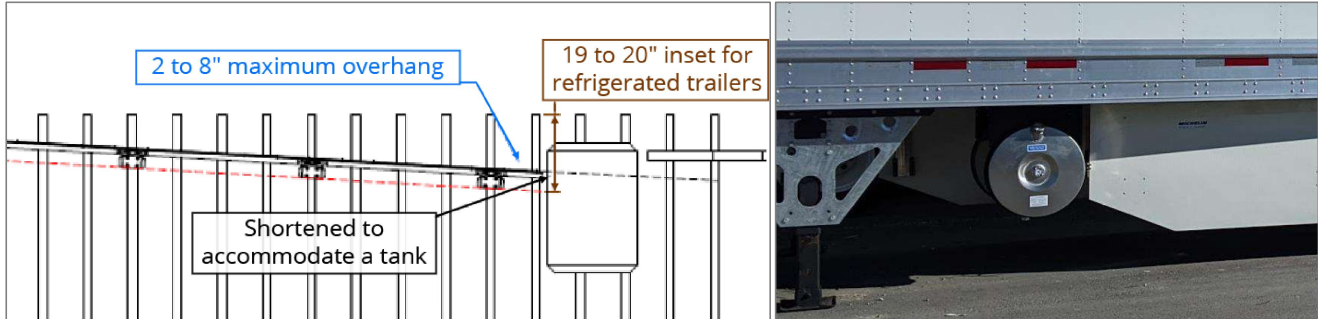

1. When trailer tires are in the forwardmost position, mark the leading edge of the tire, which is where the back edge of the skirt will be.



2. On the first cross-member in front of this mark, measure and mark a 6-inch inset from the side rail onto the underside of the cross-member. This sets the rear location for the chalk line and gives approximately a 1-inch inset of the rear of the skirt from the side rail of the trailer.



3. To create the proper angle for the skirt panel:
 - a. For a dry van trailer, mark a 22 to 23-inch inset from the side rail of the trailer, just behind the landing gear.
 - b. For a trailer with a fuel tank, mark a 19 to 20-inch inset from the side rail of the trailer, just behind the tank.
4. Snap a straight line with a chalk line on the underside of the cross-members. Use the rear and front locations as start and end points.

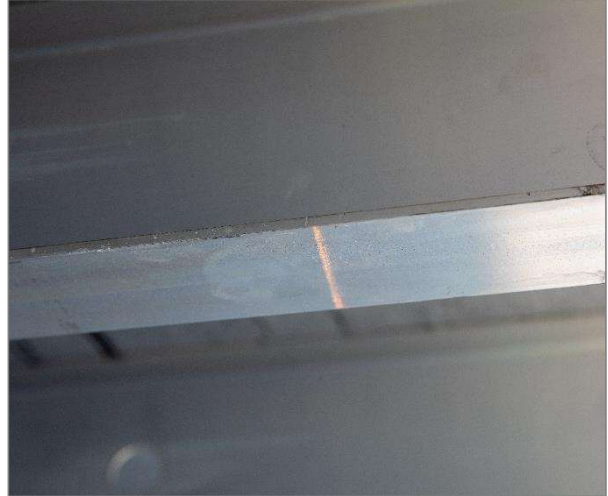

5. Repeat for other side.

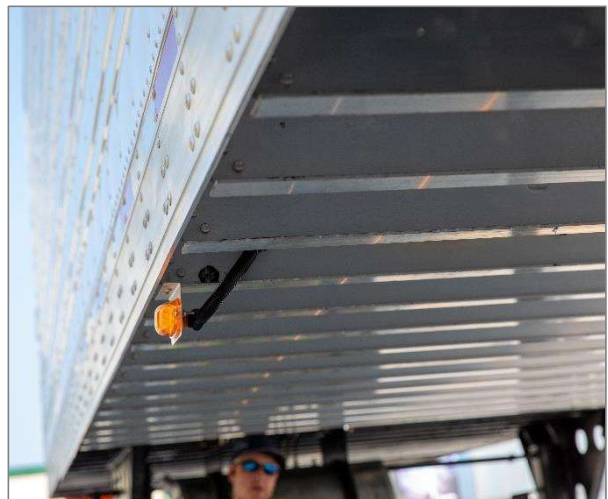

See the following diagram for a refrigerated trailer with tank example.

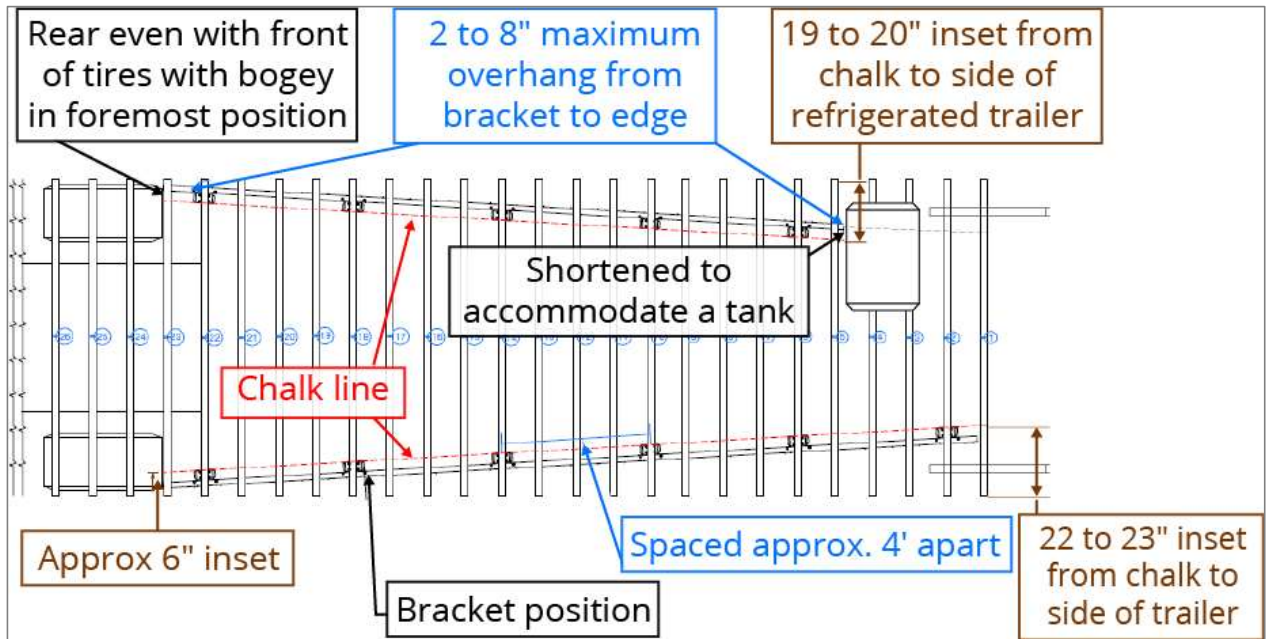

See the following diagram for a dry van trailer example.

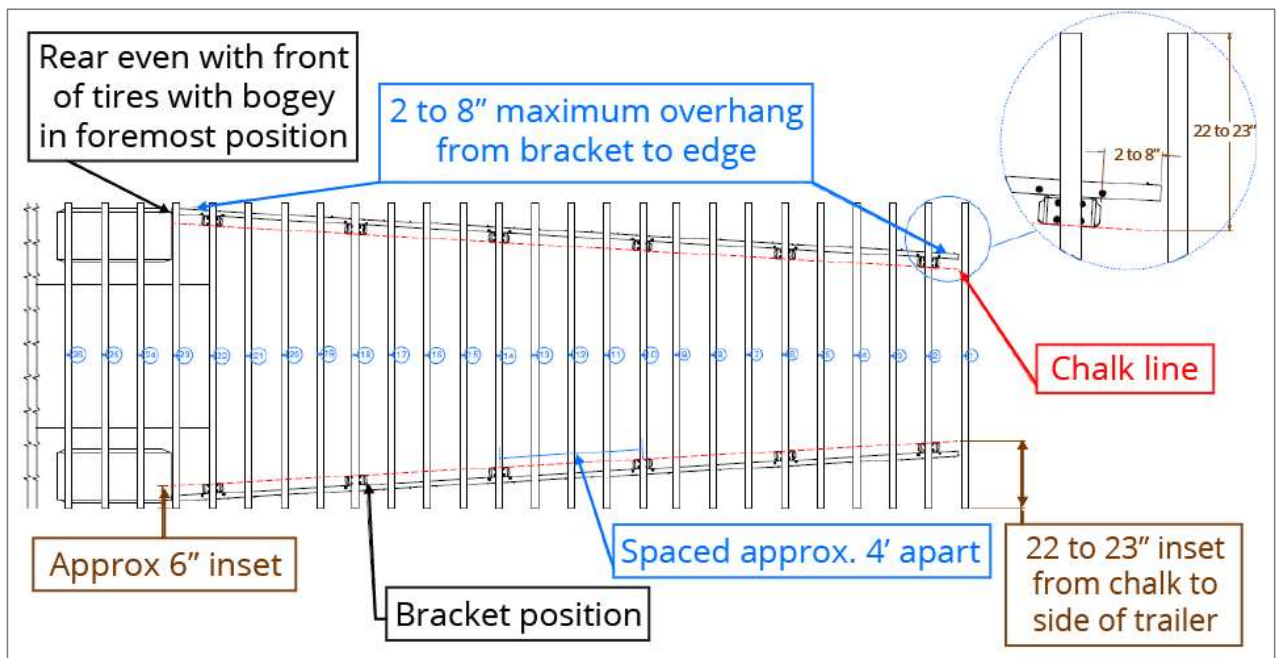

Position and Install the Brackets

Position and install the brackets in accordance with the following guidelines.

 GUIDELINES	<p>Brackets must be spaced approximately 4 feet apart.</p>
	<p>2 to 8 inches of overhang should exist from the sliders (F) to the front and rear edges of the skirt.</p>
	<p>For configurations in which 4 feet of space cannot be achieved, brackets at the front and rear of the skirt should be closest together.</p>

1. Mark (with a non-permanent marker) the skirt bracket assembly (D) locations on the side rail of the trailer.

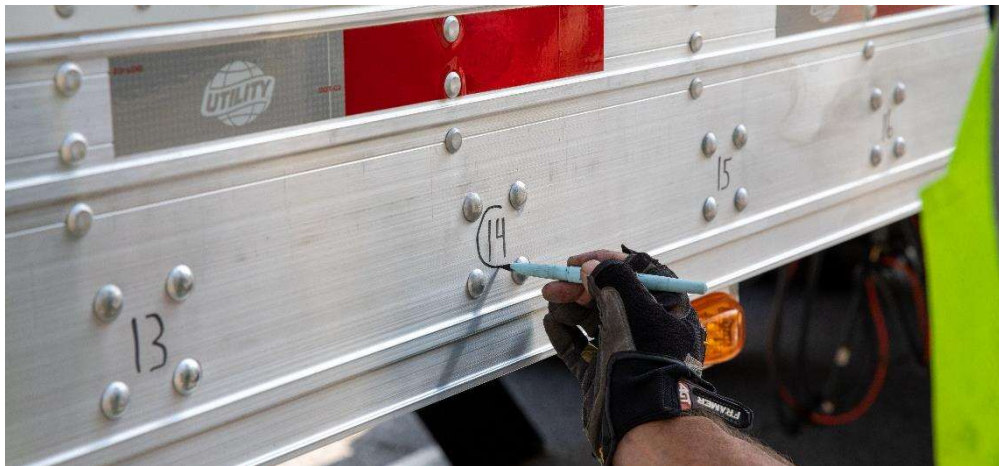

2. Position the skirt bracket assembly onto the selected cross-members. Align the back edge of the bracket with the chalk line.

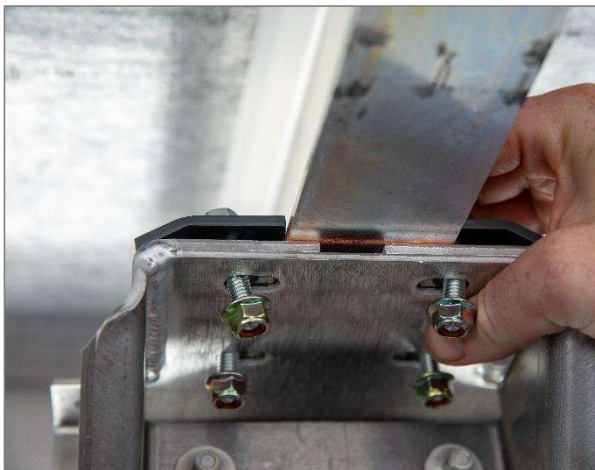

- Secure and torque the four flanged nylock nuts (**I**) and bracket bolts (**H**) to 18 to 20 ft-lb. Ensure alignment with the chalk line as the nuts and bolts are tightened. The longer bracket bolts (**K**) are used for brackets with spacers.



Hang the Skirt Panel



NOTICE

At least two people are required to hang the skirt panel.

Use proper lifting techniques as some components and packaging can weigh up to 70 pounds.

- Hang the skirt panel (**A**, **B**, or **C**) onto the brackets using the aluminum extrusion. See the image below.



- Align the rear of the panel with the rear mark on the side rail. Ensure the panel does not extend rearward past this line. The rear edge inset of the skirt panel should be approximately 1 inch from the side rail plus or minus 1 inch. It should not protrude past the side rail.



- Ensure the aluminum extrusion is fully in contact with the skirt bracket assembly. Adjust the bracket position, if necessary.
- Use a 5/16-inch drill bit to drill through the aluminum extrusion using the existing holes in the bracket as a guide.

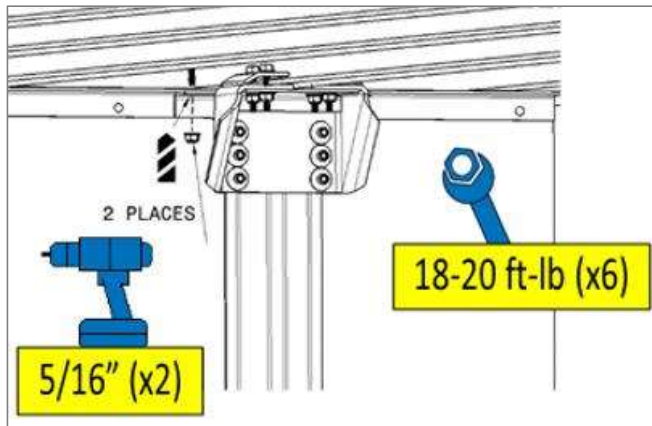

- Secure the bracket skirt assembly to the aluminum extrusion using the 5/16-inch flanged nylock nuts (I) and bracket bolts (H). Torque all six bolt locations to 18 to 20 ft-lb.

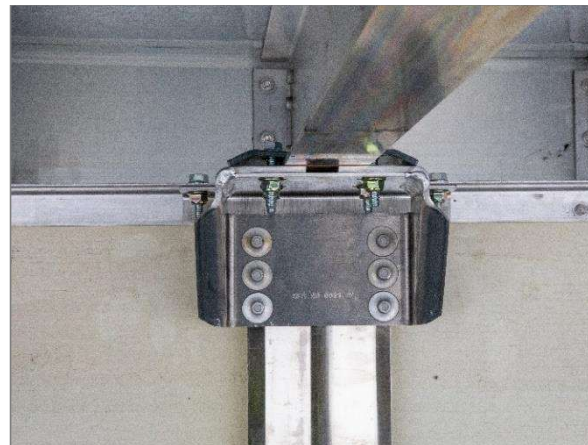

Install the Sliders

1. Ensure the bottom of the bracket slider (F) is aligned with the bottom of the leaf springs before securing the bracket slider.



2. Support the outside of the skirt and drill 5/16-inch holes in the skirt panel from the inside, using the holes in the sliders as guides.

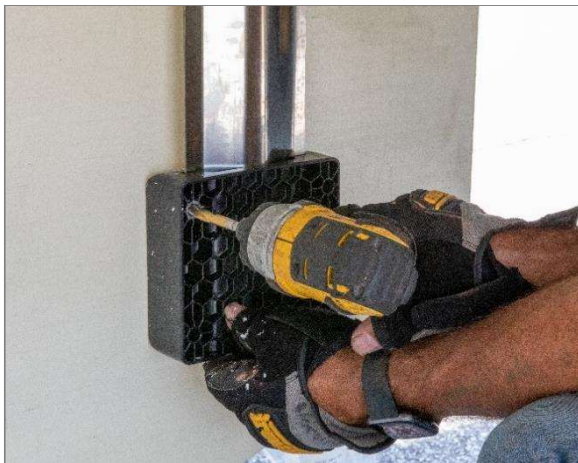

Earlier versions of the slider were two pieces. Refer to the Supplemental Instructions at the end of this manual for directions on how to replace two-piece sliders with one piece.

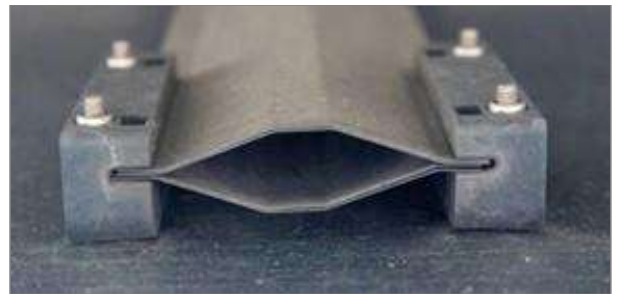

3. Insert four stainless steel bolts (J) through the holes from the outside of the skirt.



4. Use a 3/16-inch allen bit to hold the bolt head from the outside, and from the inside secure and torque the flanged nylock nuts (I) to 10 to 12 ft-lb.



5. Install the Michelin decals to the outside of the skirt panel. Refer to the Supplemental Instructions at the end of this manual for details on how to install the decals correctly.



Installation of the trailer skirt is now complete. Use the post installation checklist to verify the procedures were followed correctly.

COMPLETE THE POST-INSTALLATION AND PERIODIC INSPECTION CHECKLIST

 WARNING	Failure to follow all installation instructions can lead to component separation from the vehicle in service, which can lead to accidents, injury, and death.
--	---

Post-installation of the trailer skirt and prior to the operation of the vehicle, the mechanic should:

- Ensure the trailer skirt does not extend past the side rail of the trailer.
- Ensure the trailer skirt does not interfere or contact tires or suspension components.
- Ensure all bolts are present and torqued according to the manual.
 - a. Flange bolts/nuts (six per bracket)
 - b. Slider bolts/nuts (four per bracket)
- Check for missing cross-member clamps (two per bracket).
- Ensure brackets are properly spaced in accordance with the installation guide.
- Ensure spring sliders are aligned with the bottom of the leaf springs and the leaf springs are in the slider grooves.

For periodic inspections, the mechanic should:

- Ensure proper installation of fasteners, beam clamps, slider bracket orientation, and mounting hardware.
- Check for loose or missing components.
- Identify signs of premature wear including heavy abrasion, cracking, deformation and/or corrosion.
- Identify disengagement of bending members/stainless steel springs with slider bracket.
- Identify damages to the skirt panel, skirt panel aluminum F-channel, trailer cross-members, or skirt bracket attachment areas that would prohibit proper replacement of new bracket components.

TOP END OF TRAILER FAIRING INSTALLATION

The following figure shows the MICHELIN® Energy Guard Solution Top End of Trailer Fairing (top fairing).

Figure 3: MICHELIN® Energy Guard Solution Top Fairing



Michelin offers a top fairing for boxed frame and extended rear flange trailers. This section provides steps to install the top fairing on both types of trailers.



NOTICE

Installation of the Energy Guard top fairing can add 1.75 inches of height at the rear of the trailer. It is the end user's responsibility to ensure installation of these components does not impact legal height requirements and to plan routes accordingly.

Use the following photographs to identify a boxed frame or extended rear flange trailer.

Figure 4: Boxed Frame Trailer Photographs



Figure 5: Extended Rear Flange Trailer Photographs



WARNING

When working at heights, use proper personal protective equipment and follow all safety standards and procedures.

RECOMMENDED TOOLS/EQUIPMENT

- 3/8" torque wrench capable of 18 to 20 ft-lb
- 1/2" socket (3/8" drive)
- 1/2" combination wrench
- 5/16" drill bit
- Power drill/driver
- Hand J-roller
- 50/50 isopropyl alcohol/water mixture
- Equipment to access the top of the trailer
- Clean rags

PARTS LIST

The following table lists the top fairing parts.

Table 5: Top Fairing Parts

ITEM	PART NUMBER	DESCRIPTION	QUANTITY
L	ETFT-AS-0004-03	<ul style="list-style-type: none"> Top fairing assembly (101" to 102.5" flange) Compatible with boxed frame trailers 	Of the four listed L parts, only the one that matches your trailer door is required
	ETFT-AS-0004-04	<ul style="list-style-type: none"> Top fairing assembly (101" to 102.5" flange) Compatible with extended flange trailers 	
	ETFT-AS-0005-03	<ul style="list-style-type: none"> Top fairing assembly (100" to 101" flange) Compatible with boxed frame trailers 	
	ETFT-AS-0005-04	<ul style="list-style-type: none"> Top fairing assembly (100" to 101" flange) Compatible with extended flange trailers 	
P	HS8516801ZY	<ul style="list-style-type: none"> 5/16"-18 x 1" bolt 1/2" hex head 	4
I	HNFEL51618-G	<ul style="list-style-type: none"> 5/16"-18 flanged nylock nut 1/2" hex head 	4

Note: Not all part component assemblies are shown in the photographs. Additional part assemblies are available to fit both wide and narrow trailer roofs and boxed and extended flanges.

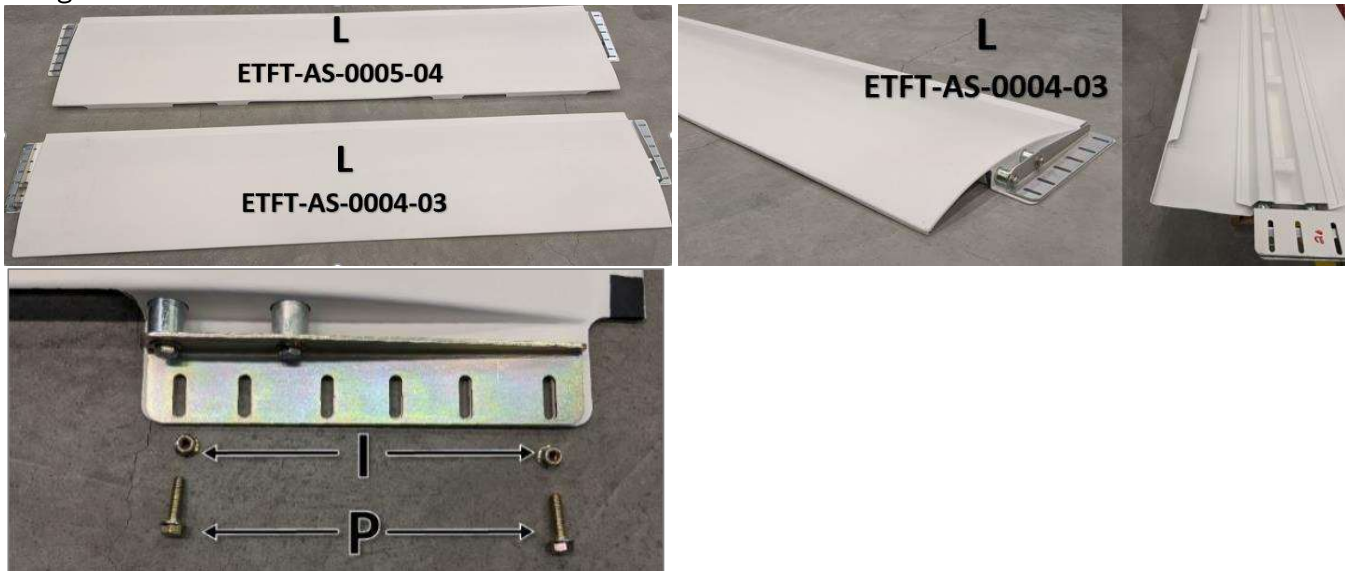

INSTALLING THE TOP END OF TRAILER FAIRING

Complete the following tasks in the following order to install the top fairing.

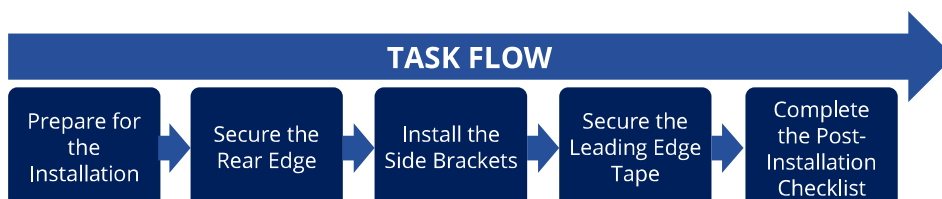

Prepare for the Installation



NOTICE

Measure the top flange of the trailer to ensure the top fairing is compatible with the trailer configuration.



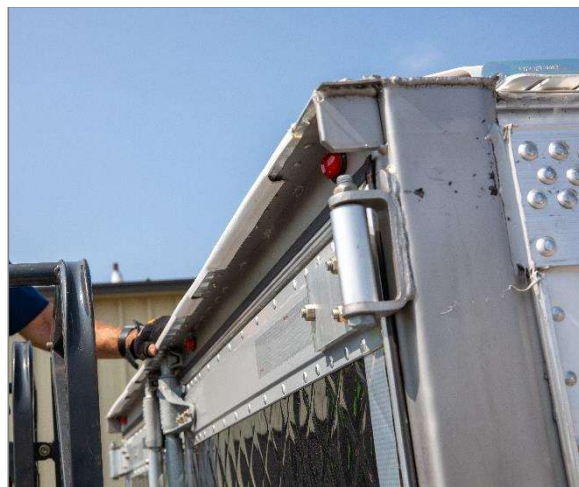

1. Verify all the required parts are present from the parts list. Verify the tape is free of defects or damage and ensure the red protective layer is fully adhered to the double-sided tape.
2. Inspect the trailer roof, top fairing and brackets before installation and ensure no damages, defects, or manufacturing abnormalities exist that may affect the top fairing installation or the leading-edge tape application.
3. Determine if the trailer you're working with is a boxed flanged trailer which requires a top fairing with a 90-degree bend or an extended flange trailer which uses a top fairing with a 180-degree bend and no tape.



Prepare the Surface and Tape

Clean the trailer roof where the top fairing tape will be installed prior to installation. Follow the surface preparation guidelines and instructions below to ensure tape adheres properly to the trailer.

 WARNING	Tape surfaces should be clean, dry, and residue free to ensure proper tape adhesion.
	Use a 50/50 isopropyl alcohol/water mixture to clean surfaces. Do not use brake cleaner.
	Tape should be installed indoors with surface temperatures of 50°F to 100°F (10°C to 38°C).
	Tape is pressure activated. Use a J-roller to apply the tape. Apply at least 15 pounds of pressure.

 NOTICE	Installation of the top fairing without full tape adhesion on the leading edge is not recommended.
	Leading edge locations relying on tape for the attachment method must achieve adhesion along 95% of the length of the leading edge tape. Any condition that prevents this level of adhesion being achieved must be rectified prior to installation of the component. Additionally, installation of the top fairing with less than full tape adhesion may result in less-than-optimal performance.
	Ensure the top fairing does not affect door function or obstruct lights. If required, trim the rear flange of the fairing.

Secure the Rear Edge

Use the following steps to secure the rear edge of the top fairing for a boxed frame.

1. Center the top fairing on the roof of the trailer and ensure the fairing does not interfere with the lights or rear door operation.



2. Clean the area where the rear edge tape will be applied.



3. Remove the rear edge tape backing on the rear edge of the top fairing.



4. With the fairing centered, push the rear edge down firmly to the roof and back of the trailer to make it adhere to the rear frame.

5. Use a J-roller to ensure proper adhesion. 15 pounds of pressure is required.



Use the following steps to secure the rear edge of the top fairing for an extended rear flange trailer. Extended rear flange trailers require a top fairing with a 180 deg rear bend with no tape.

1. Push the rear edge down and forward at the same time to fully engage the extended rear flange.



2. Ensure the top fairing is centered by checking that the distance from the panel to the side of the trailer is equal on both sides.



Install the Side Brackets

1. Use a 5/16-inch drill bit to drill two nonadjacent holes through the top flange of the trailer. Drill holes in the front and rear of the side bracket, (L). Avoid the rivets and do not drill through the bracket. Do not place bolts in the adjacent slots.



2. Install and tighten 5/16-inch bolts (P) and nylock nuts (I). Remove a small bit of the red tape on the leading edge prior to tightening the side bracket bolts and nuts.



3. Torque the bolts and nuts to 18 to 20 ft-lb.



Secure the Leading-Edge Tape

1. Clean the area of the roof where the tape will be applied.



2. Remove the red tape backing from the leading edge tape on the top fairing assembly (L) and ensure full adhesion to the roof surface.



3. Use the J-roller to roll the full length of the leading edge tape. Apply at least 15 lb of pressure to the taped area.



Installation of the top fairing is now complete. Use the post installation checklist to verify the procedures were followed correctly.

COMPLETE THE POST-INSTALLATION CHECKLIST

 <p>WARNING</p>	<p>Failure to follow all installation instructions can lead to component separation from the vehicle in service, which can lead to accidents, injury, and death.</p>
---	--

Post-installation of top fairing and prior to the operation of the vehicle, the mechanic should:

- Check the alignment of the top fairing by ensuring it is centered on the trailer.
- Ensure all 5/16-inch mounting bolts/nuts have been torqued to 18 to 20 ft-lb (two per bracket).
- Ensure the leading and trailing edge is taped down and adhered to the trailer along more than 95 percent of the length of the tape.
- Ensure brackets are properly oriented.
- Ensure the top fairing trailing edge is pushed tightly against the rear frame.
- Ensure the top fairing does not interfere with doors, locking bars, and lights.

SIDE END OF TRAILER FAIRINGS INSTALLATION

The following figure shows the MICHELIN® Energy Guard Solution Side End of Trailer Fairings (side fairings).

Figure 6: MICHELIN® Energy Guard Solution Side Fairings



Michelin offers side fairings for smooth side wall trailers and for corrugated side wall trailers. This section provides steps to install the side fairings on both types of trailers.

 <p>WARNING</p>	<p>When working at heights, use proper personal protective equipment and follow all safety standards and procedures.</p>
---	--

RECOMMENDED TOOLS/EQUIPMENT

- 3/8" torque wrench capable of 20 to 22 ft-lb
- 9/16" socket (3/8" drive)
- 3/16" drill bit
- Power drill/driver
- Hand J-roller
- Rivet gun
- Dry erase marker
- 50/50 isopropyl alcohol/water mixture and clean rags
- Equipment to access the side of the trailer

SOLID RIVET OPTION

- 3/16" drill bit
- 3/16" universal head rivet set tool
- Air-powered hammer (rivet gun) with bucking bars

PARTS LIST

The following table lists the side fairing parts.

Table 6: Side Fairing Parts

ITEM	PART NUMBER	DESCRIPTION	QUANTITY
Q	ETFS-PA-0010-01	<ul style="list-style-type: none"> • Smooth side fairing • For smooth side wall trailers 	Of the two listed Q parts, two of either the smooth side fairing or the corrugated side fairing are required
	ETFS-PA-0011-01	<ul style="list-style-type: none"> • Corrugated side fairing • For corrugated side wall trailers • Note: Corrugated side fairing parts only fit side walls with 4" x 8" x 4" spacing. 	



The following table lists the side fairing brackets and fasteners.

Table 7: Side Fairing Brackets and Fasteners

ITEM	PART NUMBER	DESCRIPTION	QUANTITY
R	ETFS-MB-0003-01	• Side Fairing Mounting Bracket (common)	6
S	HS538634Z	• 3/8"-16 x 3/4" bolt • 9/16" hex head	12
T	MBP-R6-M5	• 3/16" bulbing rivet	26-34
U	WZIP716-ZY	• 7/16" washer	12
V	AN-470-AD-6-12	• 3/16" x 3/4" solid aluminum rivet • Solid rivet option for brackets	18 (optional)

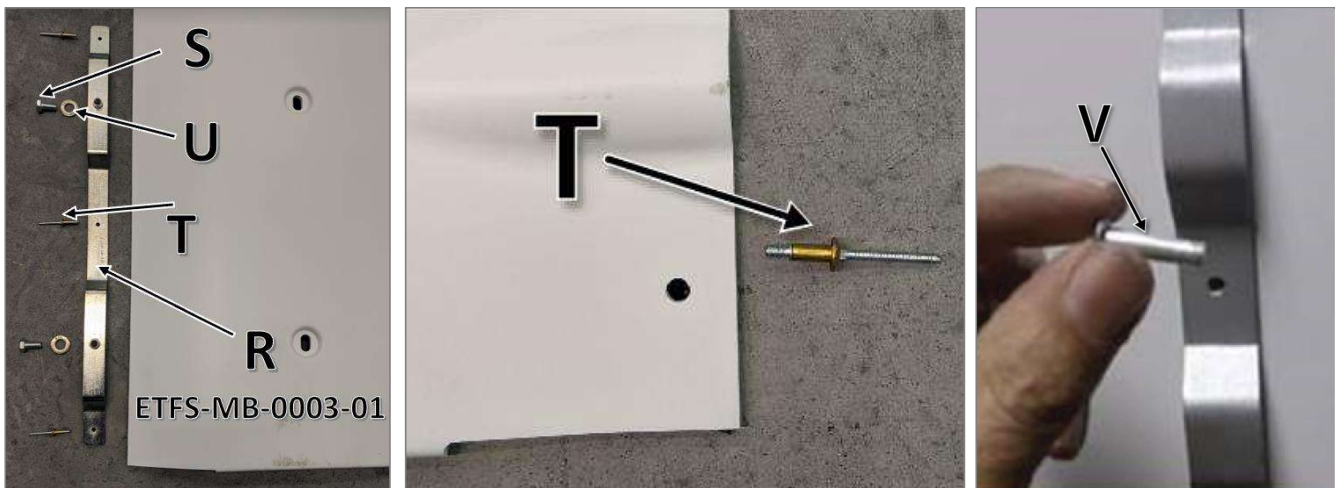

The following table lists the side fairing assembly jigs.

Table 8: Side Fairing Assembly Jigs

ITEM	PART NUMBER	DESCRIPTION	QUANTITY
W	AA-ETFS-0006-01	• Assembly jig for smooth side • Use with ETFS-PA-0002-01	Of the two W parts listed, only the one that matches your trailer is required

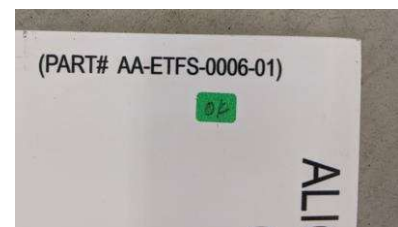
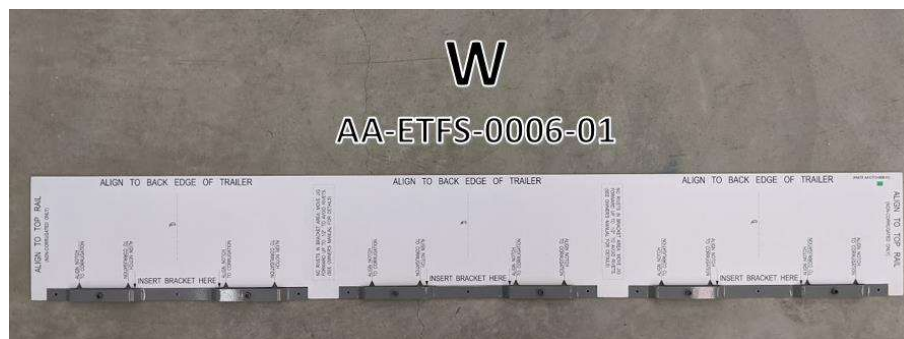

INSTALLING THE SIDE END OF TRAILER FAIRING

Complete the following tasks in the following order to install the side fairing.

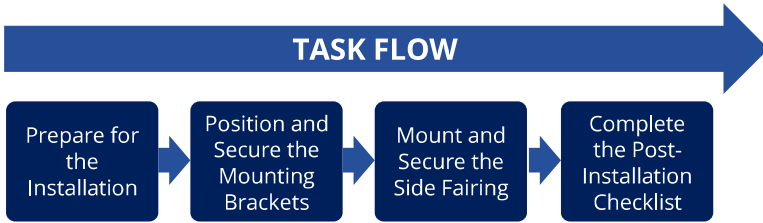

Prepare for the Installation

1. Verify all the required parts are present from the parts list. Verify the tape is free of defects or damage and ensure the red protective layer is fully adhered to the double-sided tape.
2. Inspect the trailer, side fairings, and brackets for damage or defects.

Clean all tape application surfaces prior to installation. Follow the surface preparation guidelines below to ensure tape adheres properly to the trailer.

 WARNING	Tape surfaces should be clean, dry, and residue free to ensure proper tape adhesion.
	Use a 50/50 isopropyl alcohol/water mixture to clean surfaces. Do not use brake cleaner.
	Tape should be installed indoors with surface temperatures of 50°F to 100°F (10°C to 38°C).
	Tape is pressure activated. Use a J-roller to apply the tape. Apply at least 15 pounds of pressure.

Position and Secure the Mounting Brackets

Use the jig to position the mounting brackets. **Note:** Only a spacing of 4" x 8" x 4" on the corrugation is acceptable for installations.

1. Following the instructions on the assembly jig, tape it to the side wall and ensure it is aligned with the back edge of the trailer.

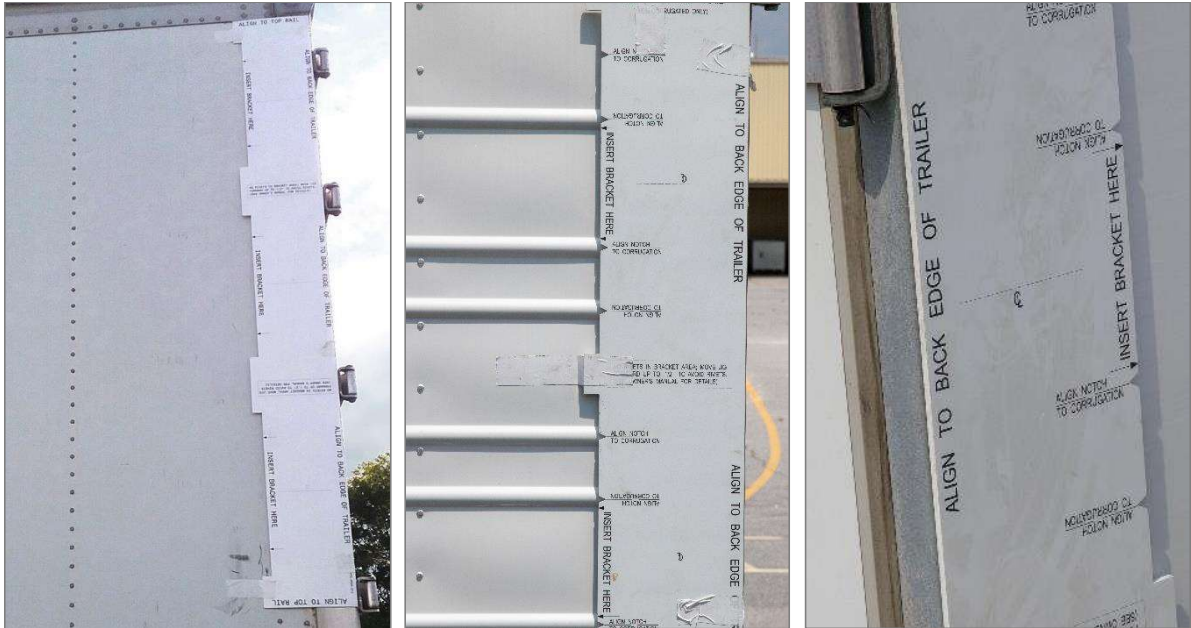

2. For a corrugated side wall trailer, position the the assembly jig (**W**) and side brackets (**R**) so that the threaded nut plate is centered on the corrugations of the of the trailer and that the bracket does not interfere with any rivets on the sidewall of the trailer.



3. Peel the tape backing off the back of the side brackets (R) and adhere to the trailer using the slot of the assembly jig.

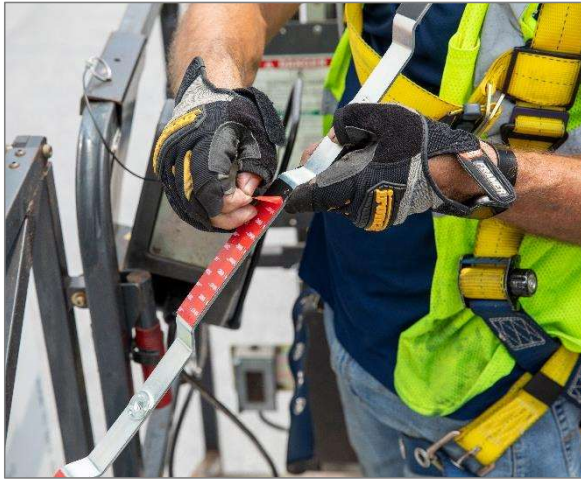

4. Ensure the panel holes align with the bracket threaded nut plates.



3. Remove the assembly jig.



- When using bulbing rivets (**T**), only drill through the outer wall of the trailer, using the three holes on the bracket (**R**) as a guide. For a refrigerated trailer, only drill through the outer wall. For solid aluminum rivets (**V**), drill through the outer and inner walls of the trailer. Use a 3/16-inch (or #11) drill bit to drill through the wall of the trailer in the locations shown below.



- Secure the brackets to the outer panel using the 3/16-inch bulbing rivets (**T**) or the solid aluminum rivets (**V**). Repeat for all hole locations.



Mount and Secure the Side Fairing

1. Use the side fairing as a guide to take note of where the tape will contact the side of the trailer. Peel off a small section of the red tape backing to ease removal in a later step.

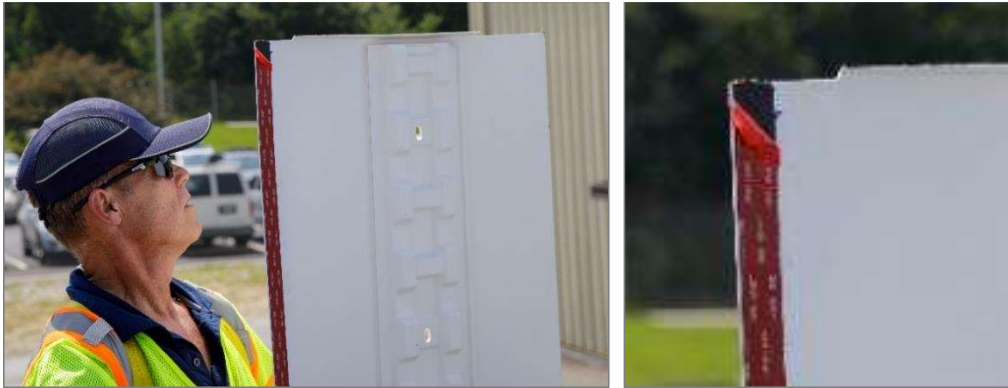

2. Position the side fairing (**Q**) onto the brackets (**R**). Ensure the flat leading edge faces toward the front of the trailer and that it does not interfere with the rivets on the trailer side wall. Do not allow the panel to extend beyond the back of the trailer.



3. Align the slots in the panel with the side brackets. Insert the 7/16-inch washer (**U**) and 3/8-inch bolt (**S**) in each location and hand-tighten. Ensure the washer goes around the threaded nut plate on the bracket during tightening.





NOTICE

Leading edge locations relying on tape for the attachment method must achieve adhesion along 95% of the length of the leading edge tape. Any condition that prevents this level of adhesion being achieved must be rectified prior to installation of the component. Additionally, installation of the side fairing with less than full tape adhesion may result in less-than-optimal performance.

4. For the corrugated side fairing (**Q**), ensure it aligns with the corrugations on the trailer first. If the corrugations do not align, loosen all the bolts and shift the fairing up or down as needed to align with the corrugations.
5. Clean and dry the area before adhering the tape.



6. Torque to 20 to 22 ft-lb.



7. Start from the top of the side fairing (Q) and down the length of the side fairing, peel the red backing off and firmly push against the tape along the entire length of the panel.



8. Use a J-roller to apply a minimum of 15 lb of pressure along the entire front edge.



9. Drill 3/16-inch holes through the outer skin of the trailer, into the pre-drilled hole positions (4 locations for smooth fairing, 8 locations for corrugated fairing) on the front of the fairing. Insert the 3/16-inch bulbing rivets (T) to fully secure the front of the panel.



Installation of the side fairing is now complete. Use the post installation checklist to verify the procedures were followed correctly.

COMPLETE THE POST-INSTALLATION CHECKLIST



WARNING

Failure to follow all installation instructions can lead to component separation from the vehicle in service, which can lead to accidents, injury, and death.

Post-installation of the side fairing and prior to the operation of the vehicle, the mechanic should:

- Check alignment of the side fairing with respect to corrugations, top rail of trailer, and rear frame.
- Ensure all necessary rivets on mounting brackets have been installed.
- Ensure 3/8-inch bolts are torqued to 20 to 22 ft-lb and that the washers are fully seated around the studs on the brackets.
- Check for missing mounting bolts (6 per fairing).
- Check for missing washers (6 per fairing).
- Ensure the side fairing is not bowed due to installation.
- Ensure the leading edge is fully taped down and riveted in at least four locations.
- Ensure the side fairing trailing edge does not extend past rear of trailer.
- Ensure the side fairing does not interfere with door operation. Some hinge bolt contact is acceptable. If significant contact exists, ½-inch holes can be drilled through the fairing on contact points to relieve interference and/or door hinge bolts can be replaced with carriage head bolts.

WAKE REDUCER INSTALLATION

The following figure shows the MICHELIN® Energy Guard Solution Wake Reducer.

Figure 7: MICHELIN® Energy Guard Solution Wake Reducer



Michelin offers three types of wake reducers:

- For swing doors with custom cutouts already present
- For swing doors that are universally blank that require cutouts to be made
- For a roll-up door

This section provides steps to install the three types of wake reducers.

RECOMMENDED TOOLS

- 1/4" drill bit
- Power drill/driver
- Rivet gun
- Center punch
- 48" straight edge
- Dry erase marker
- Hole saw for modification
- Jig saw or buzz saw for modification

PARTS LIST

The following table lists the wake reducer variations.

Table 9: Wake Reducer Parts

ITEM	PART NUMBER	DESCRIPTION	QUANTITY
X	WKD-PN-0001-00	Wake reducer panel (blank)	Of the three X parts listed, two of the parts that match your trailer door are required
	WKD-PN-0001-01	<ul style="list-style-type: none"> Wake reducer panel (with cutouts) For symmetric 2 lock rod doors 	
	WKD-PN-0002-00	Wake reducer panel (roll-up door)	

Note: The WKD-PN-0001-01 wake reducer panel (with cutouts) is not shown. It varies dependent on the trailer. For a view of WKD-PN-0002-00 wake reducer panel for a roll-up door, see the Wake Reducer Installation Examples section.

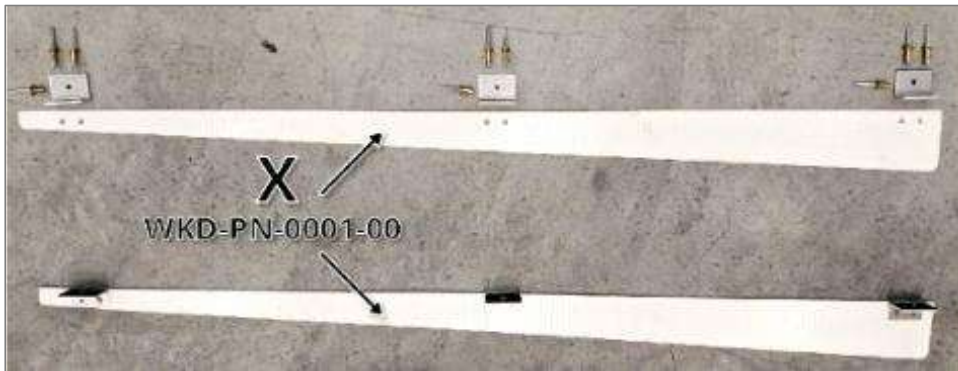

The following table lists the wake reducer brackets and fasteners.

Table 10: Wake Reducer Brackets and Fasteners

ITEM	PART NUMBER	DESCRIPTION	QUANTITY
Y	WKD-MB-0002-01	Wake reducer mounting bracket	3/panel
Z	MBP-R8-M4	<ul style="list-style-type: none"> 1/4" bulbing rivet for bracket to panel With tail and longer grip range 	2/bracket
AA	MBCP-R8-M3	<ul style="list-style-type: none"> 1/4" bulbing rivet for bracket to door Without tail and has shorter grip 	1/bracket

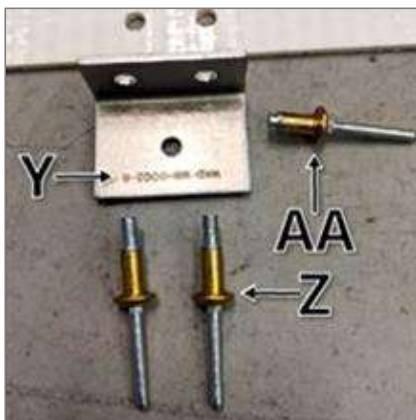

Wake Reducer Installation Examples

The following photographs show wake reducer installations.

Figure 8: Wake Reducer Installations on Swing Doors

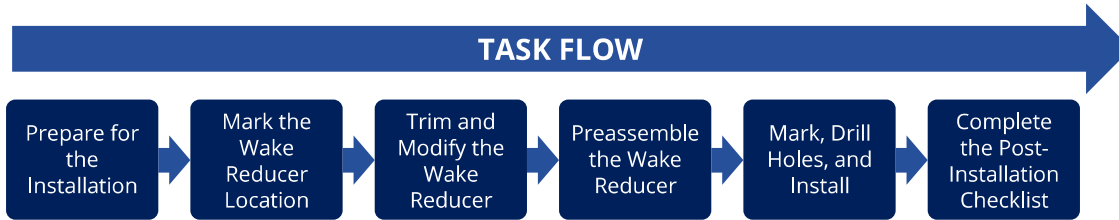

Figure 9: Wake Reducer Installation on a Roll-up Door



INSTALLING THE WAKE REDUCER

Complete the following tasks in the following order to install the wake reducer.



Prepare for the Installation

 <p>NOTICE</p>	<p>To ensure proper positioning and prevent interference with other components, Michelin recommends installing the side fairings first and then the wake reducer.</p>
--	---

1. Verify all the required parts are present from the parts list. In most cases, panels and holes have been pre-drilled into the wake reducer panel and bracket for ease of assembly. If needed, follow the steps in the Trim and Modify task to modify the panels.

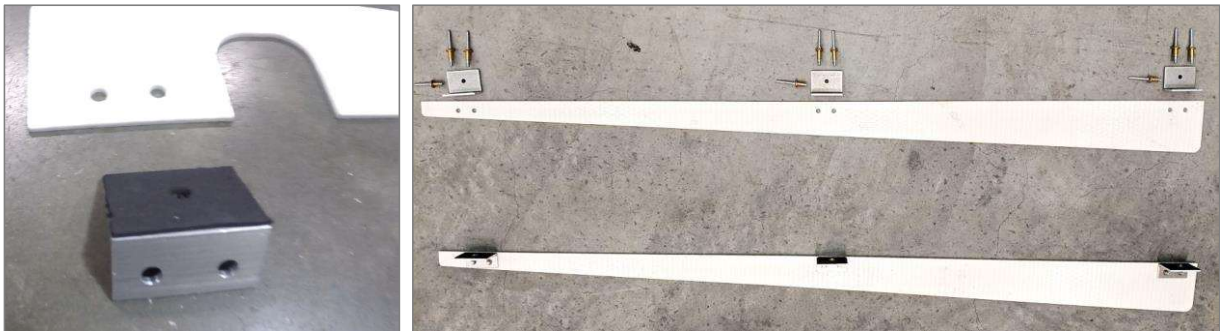

2. The installer or fleet maintenance mechanic should confirm the trailer condition is suitable for installation and operation. The installer or mechanic should:
 - Check for damage to any aerodynamic components or damage to the trailer body that may affect aerodynamic component operation or integrity.
 - Inspect the door for damage and corrosion.
 - Check for any interference with DOT placards, safety decals, and vent doors.

Mark the Wake Reducer Location

Mark the wake reducer location for a swing door or a roll-up door trailer.

SWING DOORS

1. Measure and mark 1 to 2 inches down from the bottom edge of the side fairing to determine the position of the upper outer corner of the wake reducer panels (X).



2. Measure and mark 17 to 18 inches up from the bottom of the door to determine the bottom center position of the upper inside corner of the wake reducer panels.

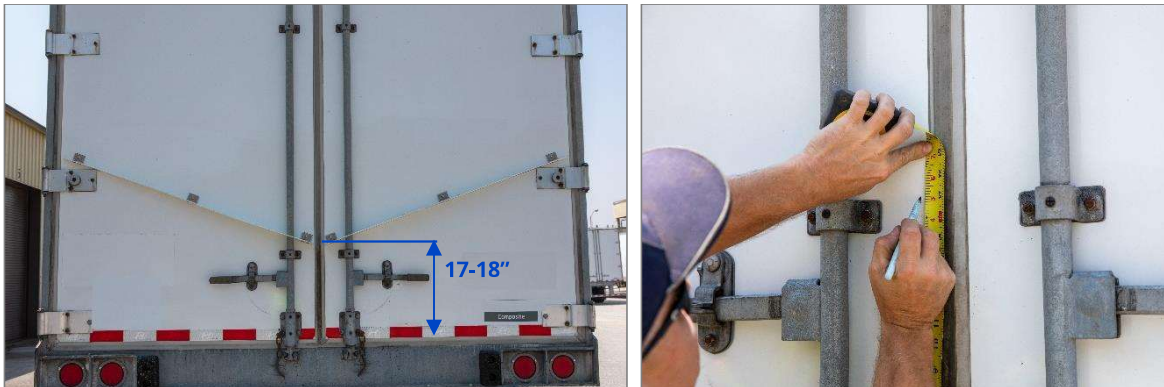

3. Position the upper edge of the wake reducer panel and draw a line between the measurements with a non-permanent marker to mark the optimal position for the wake reducer panel.



4. Repeat the process on the other door.

5. Ensure there is at least 20 inches of panel length per door with a total of at least 50 inches between both doors.



ROLL-UP DOOR

The wake reducer panel for a roll-up door sits flat across the door and is rectangular shaped to provide clearance between the wake reducer, the rear frame, and the roof of the trailer.

1. Verify clearance for the door spring cables.
2. To position the wake reducer panel (X) for a roll-up door, use the table below.

Table 11: Wake Reducer Placement on a Roll-Up Door

FORKLIFT PLATE POSITION	WAKE REDUCER PANEL TYPE	LOCATION OF WAKE REDUCER
No forklift plate	Full-length panel	22" from bottom of door
Lift plate < 16" from the bottom of the door	Full-length panel	22" from bottom of door
Lift plate between 16" and 24" at bottom of door	Two pieces	In line with lip of panel
Lift plate > 24" from the bottom of the door	Do not install	Do not install

The following photographs show the proper placement of the wake-reducer for a roll-up door with a lip/flange of forklift plate.

Figure 10: Wake Reducer Placement on a Roll-Up Door

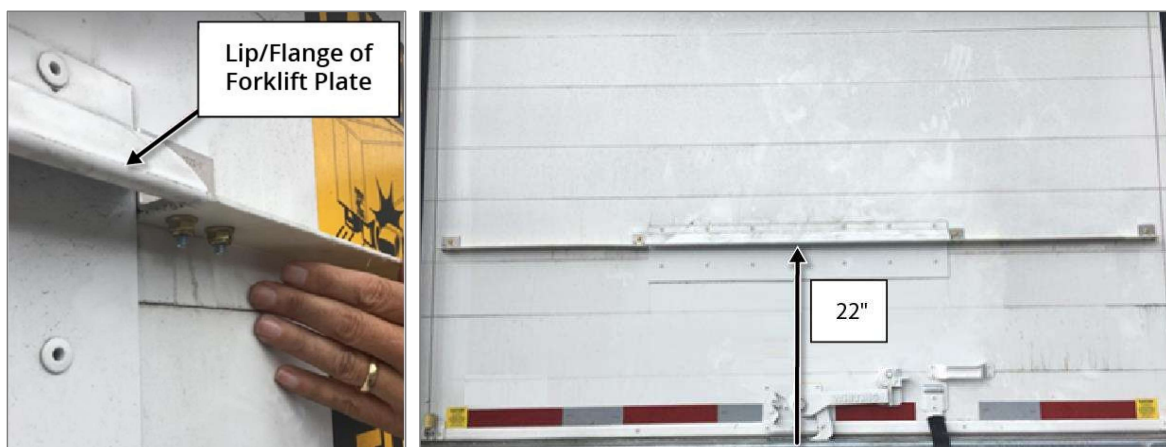

Trim and Modify the Wake Reducer

If needed, trim the wake reducers observing the following guidelines.

1. Position the upper edge of the wake reducer to determine whether anything must be trimmed.
2. Mark where to trim.
3. Use a jig saw or another appropriate cutting tool to trim the wake reducer.

 <p>GUIDELINES</p>	Ensure 20 inches minimum of wake reducer panel per door.
	Ensure a minimum of 50 inches total length of wake reducer panels between the left and right swing doors. One door can have a 20-inch wake reducer panel and the other door can have a 30-inch wake reducer panel, but there must be at least 50 inches of wake reducer panels between the two doors.
	Do not cover safety decals or labels.
	Make cuts to the wake reducer to avoid accessories, hinges, or locking bars.
	Center both the left and right wake reducer pieces at the same height with similar angles.
	Position the brackets to ensure there is sufficient support between brackets and so that no unsupported ends extend more than 4 inches on either end of the brackets.

Important! Any modifications to the wake reducer must follow these guidelines.

Any outside corners must be rounded to prevent sharp edges

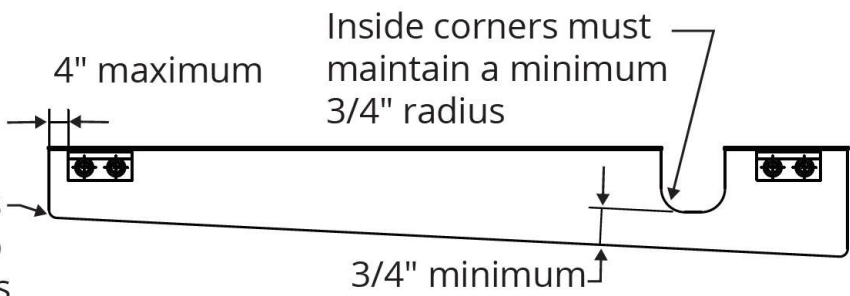

Preassemble the Wake Reducer

Use two 1/4-inch bulbing rivets (**Z**) to preassemble the wake reducer mounting brackets (**Y**) to the wake reducer panel as shown below.

Be sure to use the correct rivet with the “tail” for attaching the bracket to the panel and that the bracket is installed on the flat side of the panel.

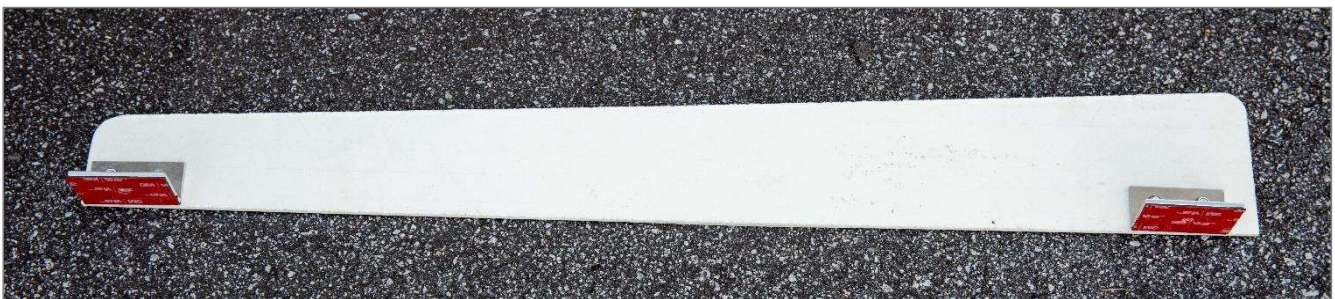
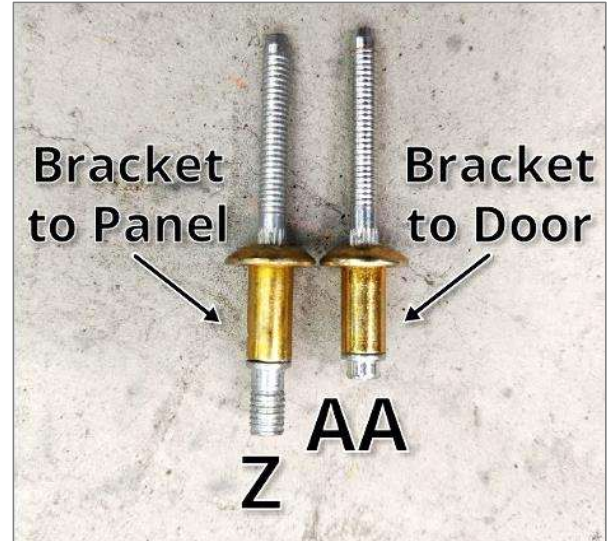
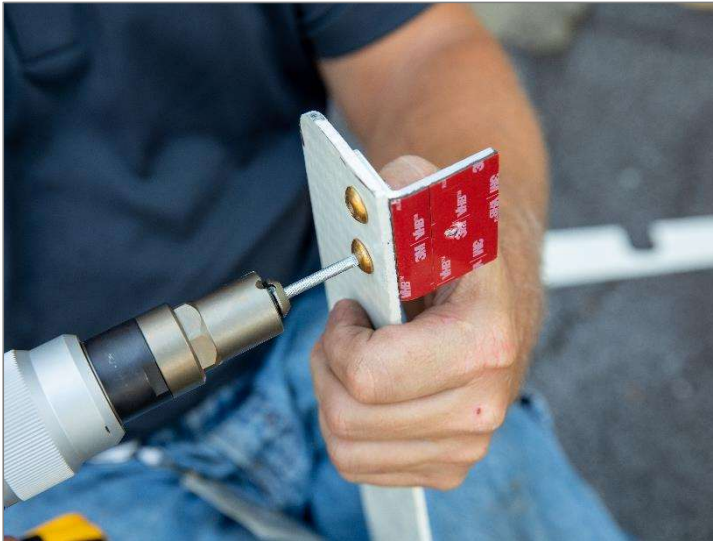

Mark, Drill Holes, and Install



GUIDELINE

Drill the center hole first and install the center bracket first. This helps ensure a straight installation.

1. Remove the red tape backing from the bracket tape.



2. Align the assembled wake reducer to the marked line and adhere the bracket tape to the door.



3. A punch can be used to center the drill bit and to help start the hole for drilling. Ensure the rivets on the refrigerated trailer doors do not pierce through the inner wall.



4. Use a ¼-inch drill bit to drill a hole through the outer skin of the door panel.



5. Insert and fasten the ¼-inch bulbing rivets (**AA**) to attach the first center bracket to the door. If the wake reducer is preassembled to the brackets, it is also attached.



6. Drill the other two holes. Insert and fasten the second and third ¼-inch bulbing rivets (**AA**).
7. On swing doors, repeat for the opposite door.

Installation of the wake reducer is now complete. Use the post installation checklist to verify the procedures were followed correctly.

COMPLETE THE POST-INSTALLATION CHECKLIST



WARNING

Failure to follow all installation instructions can lead to component separation from the vehicle in service, which can lead to accidents, injury, and death.

Post-installation of wake reducer to the trailer door and prior to the operation of the vehicle, the mechanic should:

- Check the alignment of the wake reducer to ensure it meets the desired installation position.
- Ensure the wake reducer does not interfere with the side fairing.
- Ensure the wake reducer does not limit door operation.
- Ensure the brackets are properly spaced based on the guidelines above.
- Ensure the wake reducer does not interfere with DOT placards, safety decals, or vent door operation.
- Ensure the wake reducer rivets on the refrigerated trailer doors do not pierce through the inner wall.

MUD FLAP INSTALLATION

The following figure shows the MICHELIN® Energy Guard Solution Mud Flaps.

Figure 11: MICHELIN® Energy Guard Solution Mud Flaps



Michelin offers mud flaps for dual tire or single wide base tire configurations. This section provides steps to install the mud flaps.

RECOMMENDED TOOLS

- 1/2" socket
- 1/2" combination wrench
- 3/8" torque wrench capable of 18 to 20 ft-lb

PARTS LIST

The following table lists the mud flap parts and fasteners.

Table 12: Mud Flap Parts and Fasteners

ITEM	PART NUMBER	DESCRIPTION	QUANTITY
BB	MFP-0002-01	<ul style="list-style-type: none"> • 24" x 30" aerodynamic mud flap • Dual tire configuration 	Of the two BB parts listed, 2 of the parts that match your tire configuration are required
	MFP-0003-01	<ul style="list-style-type: none"> • 18" x 30" aerodynamic mud flap • Wide base single tire configuration 	
CC	HS55168112Z	5/16"-18 x 1.5" bolt	4/flap
DD	WFE51602Z	5/16" large washer	8/flap
EE	HNFE51618-5	5/16"-18 x 1.5" nylock nut	4/flap

Note: Mud flaps are directional and must be installed in the correct orientation.

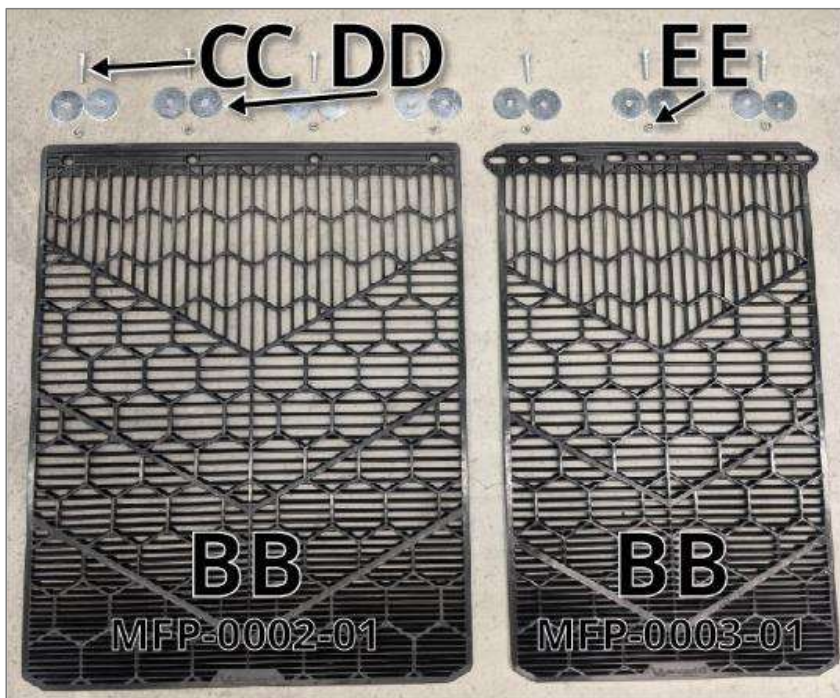

INSTALLING THE MUD FLAPS

Complete the following tasks in the following order to install the mud flaps.

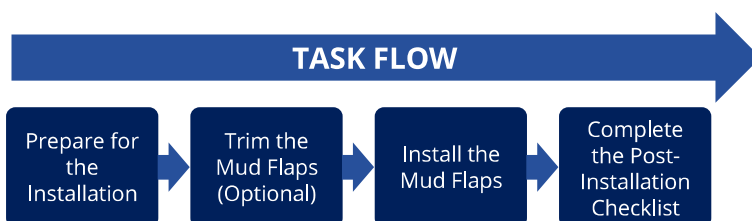



NOTICE

Michelin recommends installing the mud flap directly behind the tire, not at the rear of the trailer.

The instructions apply for both dual and single tire configurations.

If the original equipment manufacturer "strap" is used, the washers on that side can be omitted.

The mud flaps are directional. Note the installation orientation using the directions on the mud flaps.

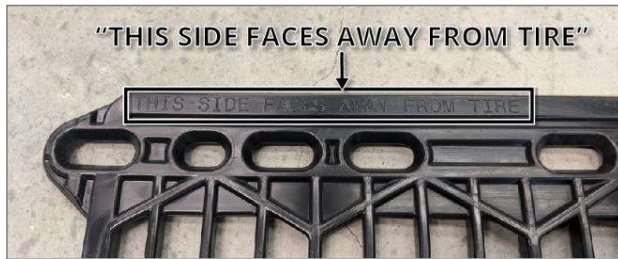

Prepare for the Installation

1. Verify all the required parts are present from the parts list.
2. Remove any existing mud flaps.
3. Inspect the trailer and mounting bracket for damage. If damaged, repair or replace prior to the installation.



Trim the Mud Flaps (Optional)

If needed, trim up to 2 inches off the bottom of the mud flaps for additional clearance. Ensure clearance meets minimum requirements.

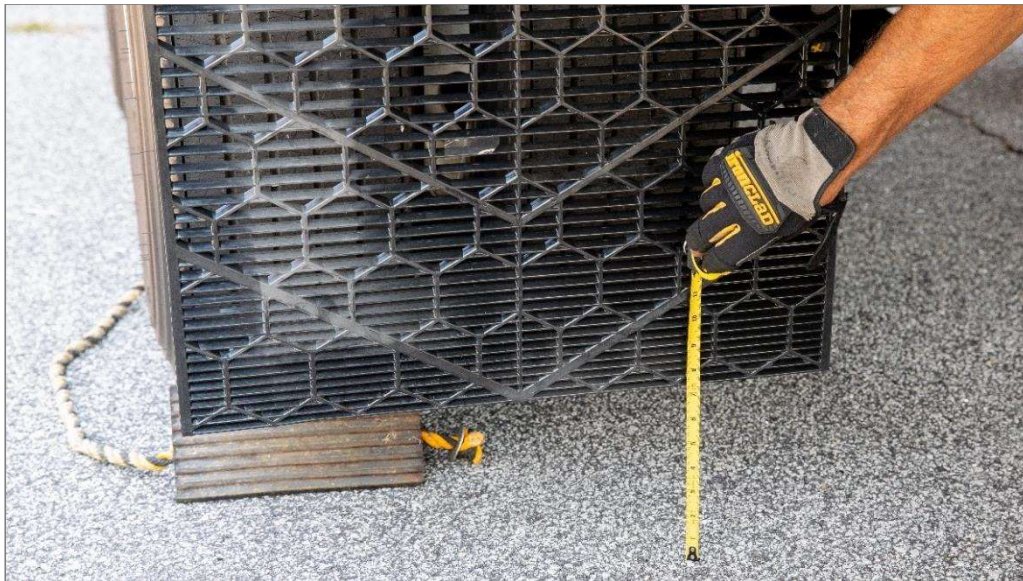

Install the Mud Flaps



WARNING

Mud flaps are directional. Failure to have the correct orientation will greatly reduce functionality.

1. Align the outside edge of the mud flap with the outside edge of the tire. Note that the Michelin logo should face the back of the trailer.

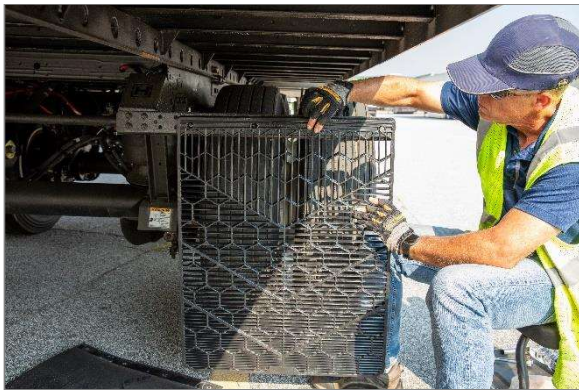

2. Use four bolts (**CC**) and four nylock nuts (**EE**) with large washers (**DD**) on both sides of the mud flap to install the mud flap.
 - a. For 18-inch-wide mud flaps, use at least three sets of bolts, nuts and washers.
 - b. For 24-inch-wide mud flaps, at least four sets of bolts, nuts and washers are required.
 - c. If the original equipment manufacturer "strap" is used, the washers on that side can be omitted.



3. Torque fasteners to 18 to 20 ft-lb.

Installation of the mud flap is now complete. Use the post installation checklist to verify the procedures were followed correctly.

COMPLETE THE POST-INSTALLATION CHECKLIST

 WARNING	Failure to follow all installation instructions can lead to component separation from the vehicle in service, which can lead to accidents, injury, and death.
--	---

Post-installation of the mud flaps and prior to the operation of the vehicle, the mechanic should:

- Check that the mud flaps were installed in the proper orientation.
- Check that bolts are torqued to 18 to 20 ft-lb.

MICHELIN® Energy Guard
Aerodynamic Solution
Limited Warranty

ABOUT THIS WARRANTY

As the original purchaser of a MICHELIN® Energy Guard Aerodynamic Solution, you are covered by all the benefits and conditions (subject to compliance with any applicable maintenance recommendations and safety warnings) contained in this document.

To ensure your understanding of and compliance with the terms and conditions of this warranty, please read it carefully.

WHAT IS COVERED AND FOR HOW LONG?**Workmanship and Materials**

Except as limited below, the MICHELIN® Energy Guard Aerodynamic Solution components listed below are covered by this LIMITED WARRANTY against defects in workmanship and materials for a period of five (5) years from the date of purchase. ALL OTHER WARRANTIES EXPRESS OR IMPLIED ARE DISCLAIMED. After the expiration of five (5) years from the date of purchase, all warranties, express or implied, expire.

The “date of purchase” refers to the date on your sales invoice. If the original sales invoice has been lost or misplaced, please contact your local Michelin representative for alternative proof of purchase solutions.

The components covered under this five (5) year limited warranty are:

- Trailer skirt
- Skirt bracket
- End fairings
- Wake reducer

WHAT IS NOT COVERED

This warranty does not cover damage to the MICHELIN® Energy Guard Aerodynamic Solution due to misuse or abuse.

This warranty does not cover MICHELIN® Energy Guard Aerodynamic Solution components that are unserviceable due to:

- Failure to install the components in compliance with the guidelines and recommendations in this Installation Guide
- Damage to the Product, Brackets, Hardware caused by in Michelin’s discretion: an external collision or the occurrence of an accident, improper use or misuse, misapplication, abusive operation, insufficient care, negligence, lack of proper upkeep, use of improper tools or substances on the components, modifications made to the Product, Brackets, Hardware
- Use on non-approved application

This warranty does not cover:

- Small deformations on side ETF (End of Trailer Fairing) due to impact with the door bolts (will not have significant negative impact on performance)
- Discoloration
- Damage to mud flaps
- Normal wear and tear from operation of the trailer by Owner consistent with sound business practices.

**** If you have a claim, please contact your Michelin Consumer Care Representative at (888) 971-3803.***

SUPPLEMENTAL INSTRUCTIONS

This section includes the following supplemental instructions:

- One Piece Slider Retrofit Supplement
- Skirt Decals Installation
- Supplemental Instructions for Composite Roof Installation of Top Fairing (When Primer is Required)
- Edge Guard Installation

Note: these instructions may not be required in all instances.

TOOLS NEEDED:

- DRILL
- 5/16" DRILL BIT
- 3/16" HEX DRIVE BIT
- 1/2" WRENCH OR SOCKET

NOTE:
 THIS INSTRUCTION APPLIES TO:
 -REPLACEMENT OF 2 PIECE SLIDER TO 1 PIECE
 VERSION

SLIDER INSTALLATION

1. REMOVE EXISTING 1 PIECE SLIDER
2. ALIGN HOLES WITH THE PREVIOUSLY DRILLED HOLES. * IF HOLES DO NOT ALIGN, IT MAY BE NECESSARY TO ENLARGE THE HOLES SLIGHTLY. IF HOLES NEED TO BE ENLARGED, USE THE PROVIDED WASHERS TO MAINTAIN FASTENER RETENTION**
3. INSERT 5/16"-18 BUTTON HEAD SCREWS THROUGH DRILLED HOLES AND TIGHTEN NUT (**TORQUE 10-12 FT. LBS.**)

****TIP:** TO PREVENT STRIPPING THE HEAD OF THE BOLT, IT IS RECOMMENDED THAT YOU HOLD THE BOLT AND TIGHTEN THE NUT**

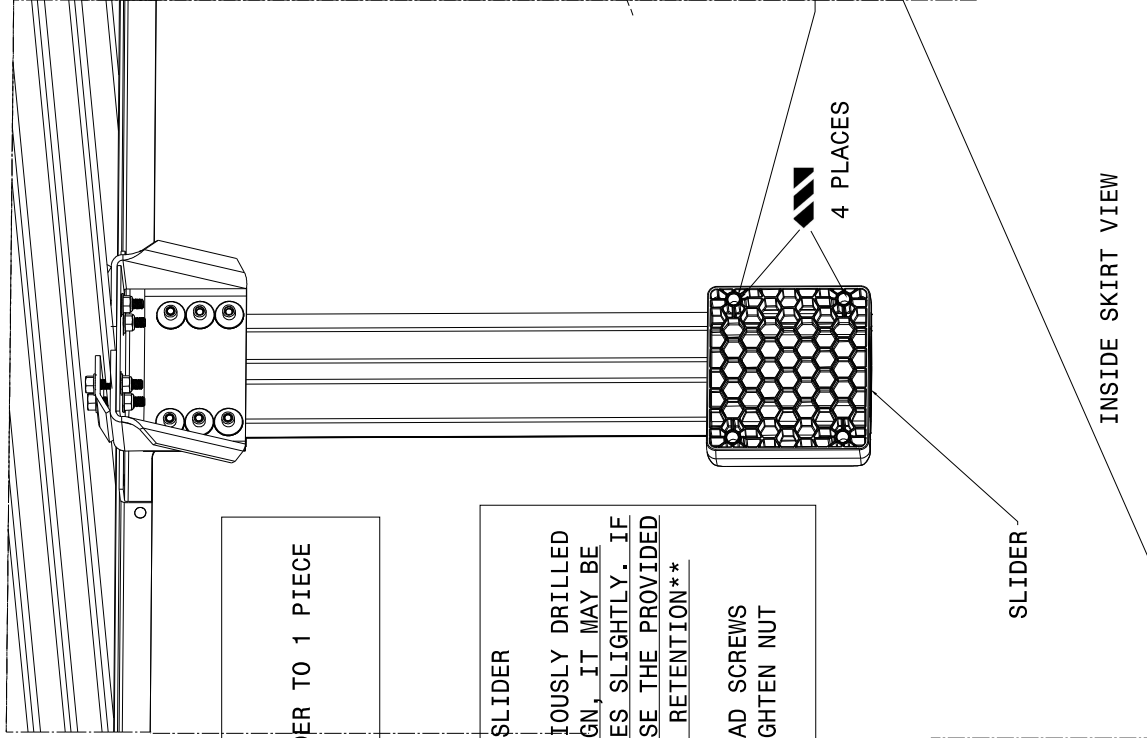

ALIGN THE HOLES IN THE SKIRT WITH THE HOLES IN THE SLIDER (FOUR PLACES)

5/16" -18
 BUTTON HEAD
 SCREWS (FOUR
 PLACES)

OUTSIDE SKIRT VIEW

4 PLACES

INSIDE SKIRT VIEW

SLIDER

PRE- INSPECTION:
 NOTICE! INSPECT EACH TRAILER FOR DAMAGE PRIOR TO INSTALLATION. DO NOT INSTALL ON A DAMAGED TRAILER.

WARNING
 FAILURE TO FOLLOW ALL INSTALLATION INSTRUCTIONS CAN LEAD TO COMPONENT SEPARATION FROM THE VEHICLE IN SERVICE POTENTIALLY LEADING TO ACCIDENTS, SERIOUS INJURY AND DEATH.

PLEASE REFER TO FULL INSTRUCTION MANUAL COMPLETE DETAILS ON INSTALLATION

MICHELIN
ONE PIECE SLIDER RETROFIT SUPPLEMENT

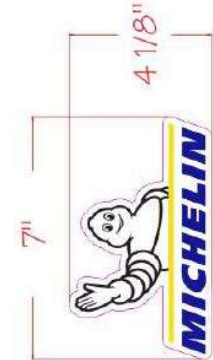
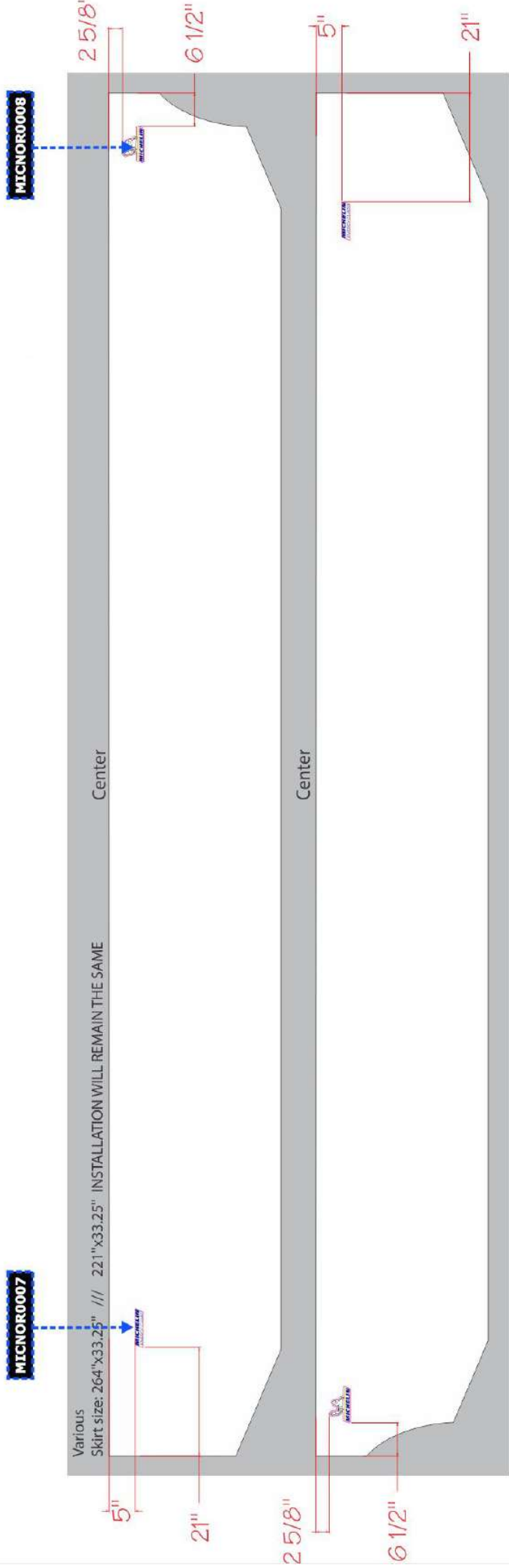

CLEANING AND PRIMING COMPOSITE ROOFS

FIGURE A

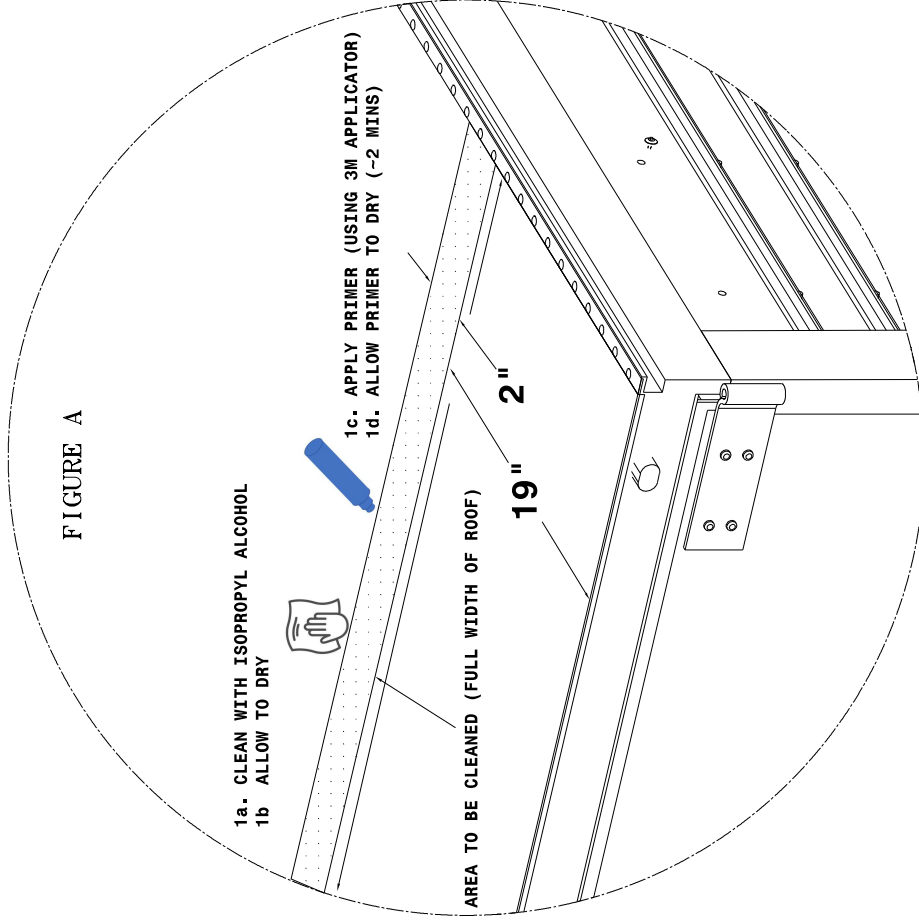

STEP 1

(FOR TRAILERS WITH COMPOSITE ROOFS)

- 1a. USING 50/50 MIX ISOPROPYL ALCOHOL/H₂O (OR ACETONE) AND A CLEAN RAG, THOROUGHLY CLEAN THE SURFACES TO BE TAPED (SEE FIGURE A)
- 1b. ALLOW THE ALCOHOL TO DRY
- 1c. APPLY PRIMER TO THE TAPE AREA WITH THE 3M APPLICATOR (SEE FIGURE A)
- 1d. ALLOW THE PRIMER TO DRY (~2MINS) BEFORE PROCEEDING TO NEXT STEP

1a. CLEAN WITH ISOPROPYL ALCOHOL
1b. ALLOW TO DRY

1c. APPLY PRIMER (USING 3M APPLICATOR)
1d. ALLOW PRIMER TO DRY (~2 MINS)

AREA TO BE CLEANED (FULL WIDTH OF ROOF)

19"

2"

S-AS-008

IMPORTANT!: FAIRINGS SHOULD BE INSTALLED IN TEMPERATURES ABOVE 50 DEGREES. TAPED SURFACES MUST BE CLEAN AND DRY. TAPE IS PRESSURE ACTIVATED (MINIMUM 15 PSI)

SEE PAGE 1 (CLEANING AND PRIMING COMPOSITE ROOFS)

STEP 1
(FOR TRAILERS WITH COMPOSITE ROOFS)

OPTIONAL STEP 2
(FOR TRAILERS WITH FLANGED REAR FRAME)

- 2a.** PLACE THE TOP FAIRING ON THE ROOF, CAREFULLY CENTERING IT AND MARKING THE FLANGE LOCATION AS SHOWN
- 2b.** INSTALL THE CLIP-ON BRACKET BETWEEN THE MARKINGS MADE IN STEP 1a., BY HAMMERING THE CLIP ONTO THE REAR FLANGE WITH A SOFT MALLET
- 2c.** CLEAN THE SURFACES WITH ISOPROPYL ALCOHOL OR ACETONE AS SHOWN
- 2d.** ALLOW THE CLEANED SURFACE TO DRY
- 2e.** ALIGN THE FAIRING SO THAT IT IS CENTERED ON THE TRAILER AND FLUSH TO THE INSTALLED CLIP-ON BRACKET

REAR FLANGE OF FAIRING
PRESSED AGAINST THE
REAR FRAME OF TRAILER

STEP 2
(FOR TRAILERS WITH FLUSH REAR FRAME)

- 2a.** PLACE THE TOP FAIRING ON THE ROOF, CAREFULLY CENTERING IT AND ALIGNING IT AGAINST THE REAR FRAME (SEE FIGURE 2)

FIGURE 2
(FLANGED FRAME FAIRING INSTALLATION)

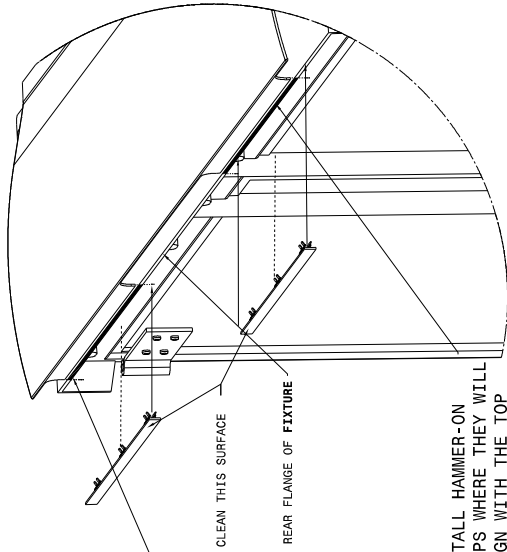

INSTALL HAMMER-ON
CLIPS WHERE THEY WILL
ALIGN WITH THE TOP
FAIRING FLANGES WHEN
INSTALLED

FIGURE 2
(FLUSH FRAME FAIRING INSTALLATION)

S-AS-008

PEEL A CORNER OF THE TAPE BACKING HERE. PEEL JUST ENOUGH THAT THE BACKING CAN BE GRIPPED AND PULLED DOWN. THE FAIRING IS BOLTED DOWN

DETAIL A

5/16-18 x 1" HEX HEAD BOLT (4 PLACES)
TORQUED TO 18-20 ftlbs

5/16" FLANGE NUT
(4 PLACES)

STEP 3
(ALIGNING AND INSTALLING TOP FAIRING)

- 3a.** USING A 5/16" DRILL BIT, DRILL HOLES THROUGH THE TRAILER FLANGE, USING THE FAIRING BRACKET AS A GUIDE, AVOIDING RIVETS (KEEP AT LEAST TWO SLOTS BETWEEN HOLES) *DO NOT DRILL THROUGH BRACKET*
- 3b.** USING THE HOLES DRILLED IN STEP 2b., INSTALL THE 5/16 X 1" BOLTS AND NUTS AS SHOWN. TORQUE 15-18 ftlbs.
- 3c.** PEEL THE BACKING FROM THE TAPE ON THE LEADING AND TRAILING EDGE OF THE FAIRING, ADHERE TO TRAILER.
- 3d.** USING A J-ROLLER, ROLL THE FULL LENGTH OF THE TAPE WITH AT LEAST 15 LBS OF EVEN PRESSURE TO ADHERE THE TAPE

IMPORTANT!: FAIRINGS SHOULD BE INSTALLED IN TEMPERATURES ABOVE 50 DEGREES. TAPED SURFACES MUST BE CLEAN AND DRY. TAPE IS PRESSURE ACTIVATED (MINIMUM 15 PSI)

STEP 1. LOCATE THE AREAS WHERE THE EDGE GUARD WILL BE INSTALLED, ROUGHLY 24-36" FROM THE EDGE OF THE TRAILER AT THE FRONT EDGE OF THE TOP FAIRING AS SHOWN.

TRY TO FIND THE AREA IN THIS LOCATION THAT ALLOWS THE EDGE GUARD TO REMAIN AS FLAT AS POSSIBLE TO THE TRAILER

FIGURE 1

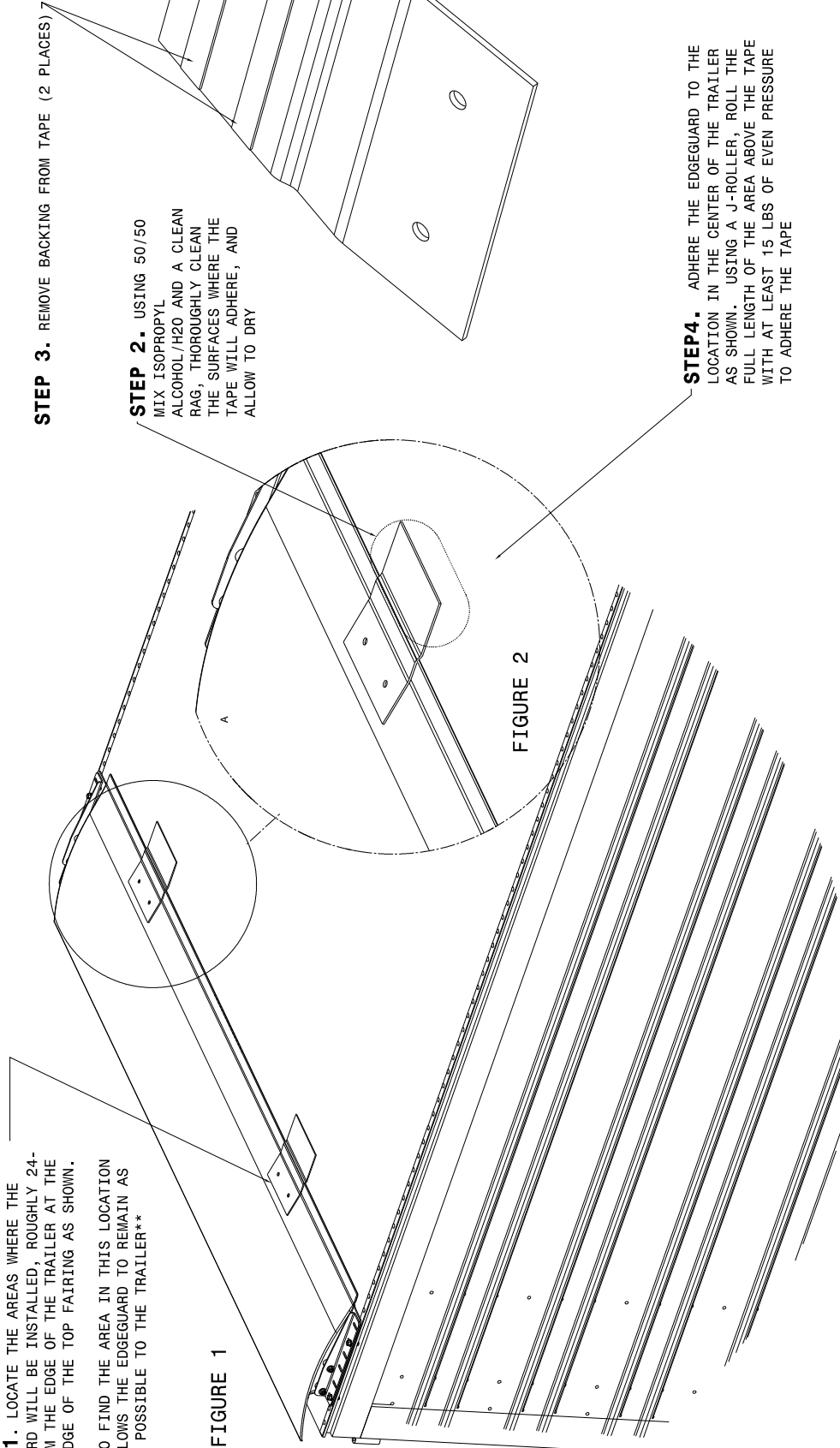

STEP 3. REMOVE BACKING FROM TAPE (2 PLACES)

STEP 2. USING 50/50 MIX ISOPROPYL ALCOHOL/H2O AND A CLEAN RAG, THOROUGHLY CLEAN THE SURFACES WHERE THE TAPE WILL ADHERE, AND ALLOW TO DRY

STEP 4. ADHERE THE EDGE GUARD TO THE LOCATION IN THE CENTER OF THE TRAILER AS SHOWN. USING A J-ROLLER, ROLL THE FULL LENGTH OF THE AREA ABOVE THE TAPE WITH AT LEAST 15 LBS OF EVEN PRESSURE TO ADHERE THE TAPE

IMPORTANT! : EDGE GUARD SHOULD BE INSTALLED IN TEMPERATURES ABOVE 50 DEGREES. TAPED SURFACES MUST BE CLEAN AND DRY. TAPE IS PRESSURE ACTIVATED (MINIMUM 15 PSI)

WARNING
FAILURE TO FOLLOW ALL INSTALLATION INSTRUCTIONS CAN LEAD TO COMPONENT SEPARATION FROM THE VEHICLE IN SERVICE POTENTIALLY LEADING TO ACCIDENTS, SERIOUS INJURY AND DEATH.

PREPARED BY: J. MORGAN DRAWN BY: J. Morgan DATE: 11/1/18 SHEET: 1/1	MICHELIN EDGE GUARD INSTALLATION RETENTION CODE : 801-102 (N/A) DRAWN BY: J. Morgan DATE: 11/1/18
--	--

THIS DOCUMENT AND THE CONCEPTS REPRESENTED HEREIN ARE PROPRIETARY AND TRADE SECRET INFORMATION OF CONSIDERABLE VALUE TO MICHELIN. IT IS NOT TO BE REPRODUCED, COPIED, OR TRANSMITTED IN ANY MANNER OR BY ANY MEANS, ELECTRONIC OR MECHANICAL, INCLUDING PHOTOCOPYING, RECORDING, OR BY ANY INFORMATION STORAGE AND RETRIEVAL SYSTEM, WITHOUT THE EXPRESS WRITTEN PERMISSION OF MICHELIN. © 2017 MICHELIN NORTH AMERICA, INC.